

# ECLIPSE®

by FUJITSU TEN

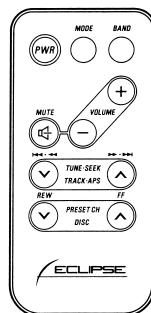
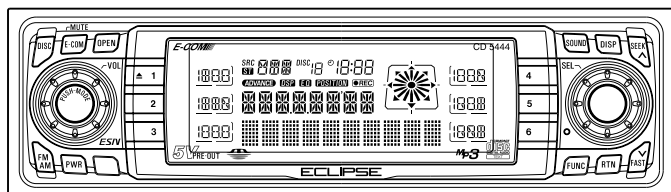

MODEL CD5444

ESN E5 High-Power "Customize" CD/MS Receiver  
with MP3/ATRAC3 Decoder and Remote

## OWNER'S MANUAL

We appreciate your purchase of this receiver.  
Please read through this manual for correct operation.  
We suggest that after reading it you keep this manual  
in a safe place for future reference.

# ***For your safety in using the CD5444***

Warnings and caution signs, illustrated below, are posted throughout this manual as well as on the CD5444. They show safe and correct ways to handle the product so as to prevent personal injury to you, others and to avoid property damage.

Before reading through the manual, take time to read through and learn the important information listed in this section.



**Warning**

This sign indicates a situation in which incorrect handling or disregard of this sign might result in death or serious personal injury.



**Caution**

This sign indicates a situation in which incorrect handling or disregard of this sign might result in personal injury or may result solely in damage to property.



**Warning**

---

- Do not modify this system for use other than that specified herein. Also, do not deviate from the installation procedures described herein; Eclipse will not be held liable for damages including, but not limited to serious injury, death or property damage resulting from installations that enable unintended operation.
- This unit is intended for operation in DC 12-volt, negative-grounded vehicles only. Never use it in 24-volt vehicles such as heavy trucks or diesel cars with cold-region specifications.
- Do not change CDs or Memory Sticks while driving. Doing so may result in an accident.

---

 **Warning**

---

- Do not place the vinyl storage bag over a person. It may cause a serious accident or death by suffocation.
- Do not adjust the controls while driving the car. To adjust the controls, stop the car in a safe location.
- To prevent accidents, store batteries for the remote control out of the reach of small children. In case a child swallows a battery, consult a physician immediately.
- Do not disassemble or rebuild this product. Doing so may cause an accident, fire or electrical shock.
- When it is necessary to replace the fuse, always use a fuse of the correct rating (number of amperes). Use of fuses with higher amperage ratings may cause a fire.
- Do not operate the product in a malfunctioning condition, for instance, when the audio does not play. Doing so may result in an accident, fire or electrical shock.
- If an abnormal situation occurs, such as foreign matter entering or liquid splashing on the product, or smoke or a strange odor emitting from the unit, shut off the product immediately and consult the dealer from whom you purchased it. Continued operation may cause an accident, fire or electrical shock.
- Do not install this product in locations where it may obstruct the driver's view, or where it may endanger passengers in the vehicle. Otherwise, an accident or injury may result.
- To prevent damaging the vehicle, confirm the locations of hoses, electrical wiring, and the fuel tank prior to drilling holes to install this product. Also, take care so that the product does not interfere, not come in contact with them. Otherwise, a fire may result.
- Do not install this product in locations where it may interfere with the operation of the steering wheel, shift lever, brake pedal, etc. Otherwise, an accident or injury may result.
- When installing this product, never use existing nuts or bolts that secure parts of the fuel tank, or the steering or braking systems. Otherwise improper steering or braking or a fire may result.

---

 **Warning**

---

- To prevent a short circuit from occurring, disconnect the battery's negative terminal before installing this product. Otherwise, an electric shock or injury may result.
- When using an existing nut and/or bolt from the vehicle to ground this product, do not use any that secure parts of the steering or braking systems. Otherwise, an accident may result.
- Bundle cables and harnesses with electrical tape or wire ties to prevent them from interfering with moving parts. If they should entangle the steering wheel, shift lever or brake pedal, an accident may result.
- Never supply power to another electrical appliance by splicing or tapping into this product's power lead (wire). Otherwise, the current capacity of the wire will be exceeded, resulting in a fire or electric shock.
- Never attempt to disassemble or modify the product. Otherwise, an accident, fire or electric shock may result.
- When replacing fuses, be sure to use fuses of the specified capacity (amperage). Otherwise, damage to the unit, fire or an electric shock may result.
- When installing the product into a vehicle with a passenger side air bag, do not secure it to the air bag's cover or in places where it may impede air bag deployment. Otherwise, proper air bag operation may not be ensured in the event of an accident, causing injury or death.
- When making holes using a drill or similar tool, be sure to wear protective eyewear. Otherwise, an injury such as loss of eyesight may result.
- Exposed wires must be insulated with electrical tape. Otherwise, a short circuit, fire, or electric shock may result.





## Caution

---

- Play the audio at a moderate volume level that permits you to hear sounds from outside the car. Driving without being able to hear outside sounds may result in an accident.
- Keep foreign objects out of the disc slot. They may cause fire or electrical shock. Another possibility is that discs may be damaged or become stuck.
- Be careful not to catch your hand/finger when opening/closing the front panel. Doing so may cause personal injury.
- Do not stick your fingers or hands into the disc slot. Doing so may cause personal injury.
- This product must be operated only as on-board equipment, or it may cause electrical shock or injury.
- Do not play distorted sounds for long periods of time; the speakers may overheat and cause a fire.
- This product uses an invisible laser light. In case a problem develops, be sure to consult the dealer from whom you purchased the product. Do not disassemble or rebuild the unit; rebuilding it may expose you and others to a dangerous laser emission (which would damage eyesight) or cause an accident.
- Never use batteries other than those specified. Do not mix new and old cells. Doing so may cause a fire or personal injury due to a battery explosion or chemical leaks.
- Pay attention to the (+) and (-) polarity of the battery when installing them in the product. Incorrect installation may cause personal injury or product damage/spoilage due to a battery explosion or chemical leakage.
- For best results, this product should be installed by a professional installer.  
Contact the dealer whom you purchased the product for an appointment.
- When installing this product, be sure to use the supplied mounting hardware. If parts other than those supplied are used, the unit may be damaged internally, or may not be held in place securely and become dislodged.



## Caution

---

- Avoid installing this product in places where it may get wet, such as near windows, or in places that are moist or dusty. Presence of liquid, moisture or dust inside this product can cause short circuiting, resulting in smoke or fire.
- Do not install this product in locations where it cannot be fastened securely, such as places subject to frequent vibration. Otherwise, it may become dislodged and cause an accident or injury.
- Do not block this product's vent or heat sink. If either is blocked, excessive heat build-up may occur and cause a fire.
- If this product is not connected properly, a short circuit, fire or accident may occur.
- When routing cables, use care so they do not contact sharp metal parts such as brackets or screw tips. Otherwise, a short circuit, electric shock, fire or accident may result.
- Do not obstruct the vent on this product. If blocked, excessive heat build-up may occur and cause a fire.

# Table of Contents

<b>Operating precautions .....</b>	<b>12</b>
Notes on operation .....	12
About compact discs .....	13
About cleaning a CD .....	15
About Memory Sticks .....	16
About cleaning the Memory Sticks .....	18
<b>Names of controls and parts .....</b>	<b>19</b>
<b>ESN security operating procedure.....</b>	<b>20</b>
About ESN.....	20
How to switch the security type (Key CD security/ Memory Stick Security) .....	21
How to operate the ESN (Key CD)security .....	22
How to program the Key CD .....	22
How to cancel the Key CD .....	23
How to change the Key CD.....	24
How to resume normal operation (ESN security lock out) .....	24
What happens if an incorrect CD is inserted?.....	25
How to operate the ESN (Memory Stick) security .....	26
How to record a security code .....	26
How to cancel the Memory Stick security .....	28
How to change the Memory Stick .....	30
How to resume normal operation (ESN security lock out) .....	31
What happens if a Memory Stick or security code is incorrect?.....	34
How to operate the ACC security .....	36
How to turn the security indicator on/off .....	36
How to read the Electronic Serial Number .....	37
<b>Basic operation .....</b>	<b>38</b>
Turning the power on and off .....	38
Listening to a CD.....	39
Listening to MG Memory Stick .....	40
Listening to the tuner .....	41
Adjusting audio volume .....	42
Switching audio control modes.....	43
VOL (VOLUME) Mode .....	43
BASS Mode .....	43
TREB (TREBLE) Mode .....	44
BAL (BALANCE) Mode .....	44
FAD (FADER) Mode .....	44

NON-F (NON-FADER) Mode .....	44
SVC (Source Volume Control) Mode .....	45
Enabling the loudness control .....	46
Making changes with Display Adjustment Mode .....	47
Contrast adjustment .....	48
Changing illumination color .....	48
Making changes with Function Mode .....	49
Disabling the guide tone feature (for button operation).....	50
Clock display on/off .....	50
Setting the Time .....	51
Others.....	52
Enabling E-COM feature.....	52
Operation assist function .....	52

***How to operate the CD player.....53***

Listening to CDs .....	53
Advancing to the next track or returning to the beginning of the track being played .....	54
Fast Forward/Rewind .....	54
Playing the beginning of tracks (SCAN) .....	54
Repeating the same track (REPEAT).....	55
Playing tracks in random order (RANDOM) .....	55
Ejecting the disc .....	56
Creating a title for a CD.....	57
Changing a previously set title .....	59
Deleting a previously created title .....	60
Displaying CD TEXT .....	61

***How to operate the MP3 player .....62***

About MP3.....	62
What is MP3?.....	62
Playable MP3 file standards .....	62
ID3 tags.....	62
Media .....	63
Format of discs .....	63
File names .....	64
Multi-sessions .....	64
Playing MP3.....	64
MP3 playing time display .....	64
Display order of MP3 file/folder names .....	64
Listening to MP3 file.....	65
Advancing to the next track (file) or returning to the beginning of the track (file) being played .....	66
Skipping to the next or previous folder .....	66
Return to the root directory of the CD .....	66

Playing the beginning of files (SCAN) .....	67
Repeating the same file (REPEAT) .....	67
Playing files in random order (RANDOM) .....	68
Displaying title .....	68

### ***How to operate the Memory Stick player.....69***

Listening to MG Memory Stick .....	69
Advancing to the next track or returning to the beginning of the track being played .....	70
Fast Forward/Rewind .....	70
Playing the beginning of tracks (SCAN) .....	70
Repeating the same track (REPEAT).....	71
Playing tracks in random order (RANDOM) .....	71
Ejecting the Memory Stick.....	72
Recording on Memory Stick .....	73
Selecting tracks to be recorded.....	74
Setting sound quality .....	75
Deleting recorded file .....	76
Formatting MG Memory Stick (quick format).....	77

### ***How to operate the tuner .....78***

Tuning to a station.....	78
Entering stations into memory automatically (The automatic preset mode: ASM) .....	79
Manually setting stations into memory .....	80
Preset station scan.....	81
Setting a station name.....	82
Deleting a station name.....	84
Changing the reception sensitivity for automatic scanning .....	85
Changing the radio band location.....	86
FM reception characteristics .....	87
FM reception differs from AM.....	87
Fading out.....	87
Reception area of FM broadcasts.....	88
Multipath .....	88

### ***How to operate the Sound Adjustment Mode .....89***

About Sound Adjustment Mode.....	89
Position selector.....	89
DSP.....	89
Graphic equalizer.....	90
Parametric equalizer .....	90
Crossover.....	92
Time alignment .....	94
Multi-harmonizer .....	95

Non-fader phase .....	95
E-iSERV sound effect customizations .....	95
Operations during Normal Mode .....	96
DSP setting .....	97
Position selector setting (POSITION) .....	98
Non-fader phase selection (NON-FADER) .....	99
Operations during Advance Mode.....	100
Equalizer adjustment (EQ).....	101
Simplified time alignment settings (T-ALIGN) .....	106
Crossover adjustment (X-OVER).....	111
Multi-harmonizer settings (HARMONIZER) .....	112
Non-fader phase selection (NON-FADER) .....	113
Reading sound quality data .....	114

### ***How to use the Card remote control.....116***

Precautions in use of the remote control.....	116
Cleaning the remote control .....	116
Turning the power on/off .....	117
Adjusting the audio volume .....	117
Muting the volume.....	117
Switching playback modes .....	118
How to play the tuner .....	118
Selecting the FM/AM band.....	118
Selecting a station (manually or automatically).....	119
Selecting preset stations.....	119
How to play CDs .....	119
Switching disc modes .....	119
Advancing to the next track or returning to the beginning of the track being played .....	120
Skipping to the next or previous disc .....	120
Enabling the optional E-COM feature.....	120
Replacing the battery .....	121

### ***How to use an optional NOB remote control ..... 122***

Turning the power on/off .....	122
Adjusting the audio volume .....	122
Muting the volume.....	122
Switching playback modes .....	123
How to play the tuner .....	123
Selecting the FM/AM band.....	123
Selecting a station (manually or automatically).....	124
Selecting preset stations.....	124
How to play CDs.....	124
Switching disc modes .....	124

Advancing to the next track or returning to the beginning of the track being played .....	125
Skipping to the next or previous disc .....	125
Illuminating the NOB remote control .....	125
Enabling the optional E-COM feature.....	125
Replacing the battery .....	126

***How to operate the receiver with an optional CD changer connected..... 128***

Listening to a CD.....	128
Advancing to the next track or returning to the beginning of the track being played .....	128
Fast Forward/Rewind .....	128
Playing the beginning of tracks (SCAN) .....	129
Repeating the same track (REPEAT).....	129
Playing tracks in random order (RANDOM) .....	130
Skipping to the next or previous CD.....	130
Specifying a CD to play .....	131

***Others ..... 132***

Connecting Portable Audio Players to the AUX Jack.....	132
--	-----

***If you have a question: ..... 133***

Displayed information (for troubleshooting).....	134
--	-----

***Specifications ..... 138***

***Before installation..... 139***

Components .....	139
Installation angle .....	139

***Mounting instruction ..... 140***

Mounting the main unit.....	140
Names of lead wires and destinations .....	142
System .....	143

***How to contact customer service ..... 148***

## Operating precautions

<Your CD5444 will perform well over a long period of time through correct handling and care.>

### Notes on operation

- For your safety, play only at volume levels that allow outside sounds to be heard.



- We recommend using with this player a disc with the logo shown to the left.
- You can play music CDs (CD-R/CD-RW) on this player. Be sure to use discs that have been properly processed.

Depending on the editing equipment used, some discs may not play properly.

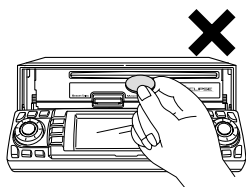

- Do not insert anything other than a CD and a Memory Stick into the disc slot.

Do not insert any foreign objects, such as coins or credit cards, into the disc slot. Be especially watchful of children's mischief in this regard.



- Avoid severe mechanical shock. When the player is subjected to severe vibration while traveling over a rough surface, playback may be intermittent. When a situation like this occurs, resume playback after returning to a smoother road.



- About dew condensation. In cold or rainy weather, just as the interior glass surface gets fogged, dew (water condensation) may also settle on the deck. When this occurs, disc playback may become intermittent or impossible. Dehumidify the air in the vehicle for a while before resuming playback.

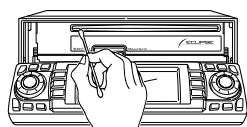

- Cleaning the disc slot. The disc slot tends to get dusty. Clean it occasionally to prevent accumulated dust from scratching the discs.



## About compact discs

- The signal recorded on a compact disc is read by a laser beam, so nothing touches the disc surface. A scratch on the recorded surface or a badly warped disc may cause deteriorated sound quality or intermittent playback. Observe the following precautions to ensure high quality sound performance:

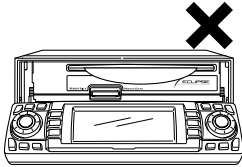

- Do not leave an ejected disc in the disc slot for very long; the disc may warp. Discs should be stored in their cases and kept away from high temperature and humidity.

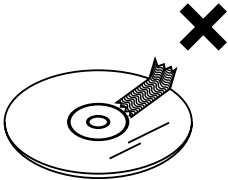

- Do not stick a piece of paper or tape on, nor write on or scratch either side of a disc.

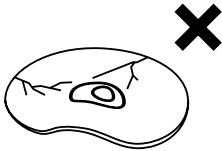

- Discs spin at a high speed inside the deck. Keep cracked or warped discs out of the player to avoid damaging it.

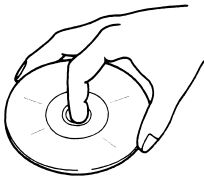

- Avoid touching the recorded surface when handling a disc; handle discs by their edges.

### About brand new CDs

- You may notice that some brand new discs are rough around the center hole or outside edge. Remove the rough edges with the side of a ballpoint pen, etc. Rough edges may prevent proper loading in the deck. Flakes from the rough edges may also stick to the recorded surface and interfere with playback.

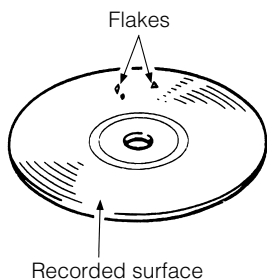
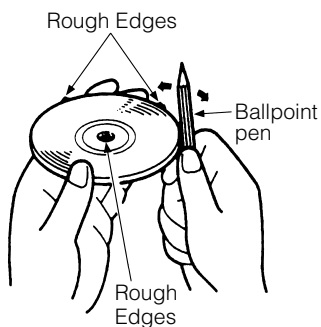

### About CD accessories

- Do not use accessories (stabilizers, protective seals, laser lens cleaners, etc.) sold for "improving sound performance" or "protecting CDs." The changes in CD thickness or outside dimensions made by these accessories may cause problems in the player.

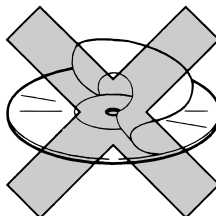

- Please be sure NOT to attach any ring-shape protector (or other accessory) to your discs. Those protectors are commercially available and said to protect disc and to improve sound quality (and antivibration effect), but they can do more harm than good in regular uses. The most common problems are disc insertion, disc ejections, and won't play problems due to the protector ring that came off in the disc mechanism.

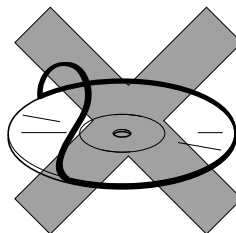

**About borrowed CDs**

- Do not use a CD with glue or remnants of adhesive tape or labels. They may cause the CD to get stuck inside or damage the deck.

**How to remove CDs**

- When removing the ejected disc, pull it straight out along the slot. Pressing downward in the process may scratch the recorded surface of the disc.

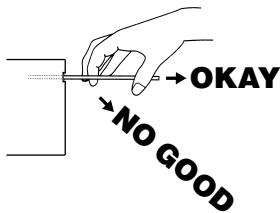

**About irregularly-shaped CDs**

- Specially-shaped CDs, like heart-shaped or octagonal CDs, cannot be played. Do not attempt to play them, even with an adapter, since they may damage the player.

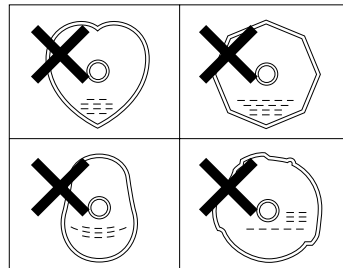

**About cleaning a CD**



- Use a commercially available compact disc cleaner to clean a CD, wiping lightly from the center to the edge.

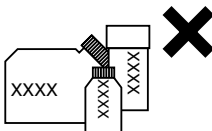

- Do not use benzine, thinner, LP record spray or other cleaners on CDs. They may damage a CD's finish.

## About Memory Sticks

- Do not store Memory Sticks in places that are subject to static electricity and electrical interference, otherwise the data they contain may become corrupted.
- In order to protect the player, the player's functions will be stopped automatically if a problem occurs. If the player cannot be operated even after following the instructions that appear on the screen, the unit is malfunctioning, and you should ask the place of purchase for further advice.
- If using a Memory Stick Duo, you will need to use it with a Memory Stick Duo adapter.
- Only Memory Sticks with a capacity of up to 128 MB can be used in the unit.
- Memory Stick PRO types of Memory Stick cannot be used.
- If MG Memory Stick is not being used for prolonged time, remove it from the deck.
- MG Memory Sticks bearing one of the marks at the left can be used.
- Memory Sticks bearing one of the marks at the left can be used for writing and reading data other than music data.

**MAGICGATE**



MagicGate Memory Stick  and Memory Stick  are trademarks of Sony Corporation.

- If the write protection switch on a MG Memory Stick or Memory Stick is at the lock position, audio recordings and other data cannot be saved onto it.
- Do not remove a MG Memory Stick while it is being accessed for playback or recording, otherwise the data on the MG Memory Stick may become corrupted. If the data becomes corrupted, it can no longer be retrieved.
- Please format the MG Memory Stick on this deck. A MG Memory Stick formatted by another this deck may not be playback or record data.
- When a Memory Stick is formatted, all data on that Memory Stick will be erased. (Included Memory Stick security recorded data and sound quality data)

- It may not be possible to use MG Memory Sticks that have just been purchased. If this happens, use the unit to format the MG Memory Stick. Refer to "Formatting MG Memory Stick (quick format)" on page 77 for instructions on formatting MG Memory Sticks.
- Some recordings and other data may not be played back or writing/reading, depending on the device that was used to save the data.



- Do not use Memory Sticks with labels that are peeling off or that have name tags (labels) attached.

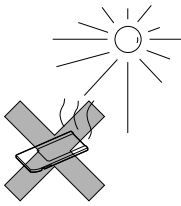

- Store Memory Sticks in places away from direct sunlight and high humidity, otherwise the Memory Sticks may become unusable.

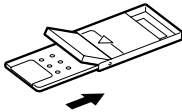

- Place Memory Sticks in their protective cases during transportation and storage.

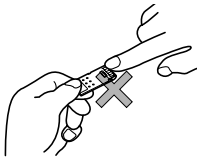

- Do not touch the terminals with your hands or with metallic objects.

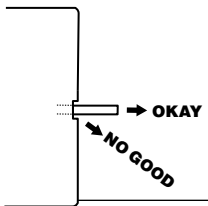

- When removing the ejected Memory Stick, pull it straight out along the slot. Pressing downward in the process may scratch the recorded surface of the Memory Stick.

## About cleaning the Memory Sticks

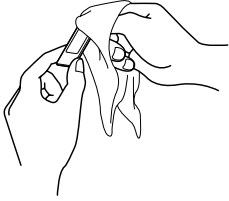

- In order to maintain good audio performance from Memory Sticks, periodically wipe the cartridge clean of any dust and other contamination with a dry cloth.

# Names of controls and parts

## Front view

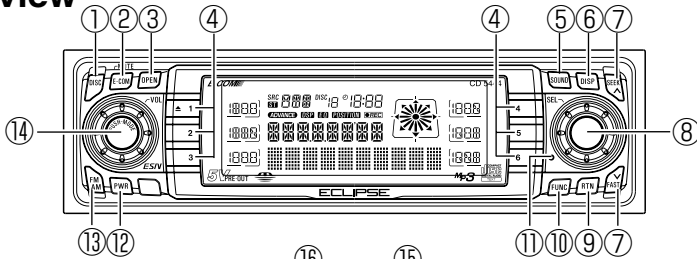

## With the front open

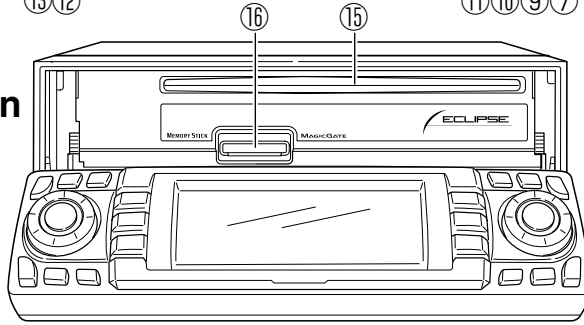

Caution

Never place an object or rest your hands or the like on the front panel.

①	<b>[DISC] button</b>	Switches disc modes and switches to AUX mode.
②	<b>[E-COM] button*</b>	Activates and deactivates mute.
③	<b>[OPEN] button</b>	Opens/closes front panel.
④	<b>Buttons [1] to [6]</b>	Selects radio preset channels and performs disc mode functions.
⑤	<b>[SOUND] button</b>	Turns the sound adjustment mode ON/OFF.
⑥	<b>[DISP] button</b>	Turns screen adjustment mode ON/OFF and switches screen display.
⑦	<b>[SEEK <math>\wedge</math> /FAST V] button</b>	Automatically finds radio reception and fast forward/rewind.
⑧	<b>[SEL] button</b>	Selects radio stations and CD tracks.
⑨	<b>[RTN] button</b>	Returns to previous screen.
⑩	<b>[FUNC] button</b>	Turns function mode ON/OFF.
⑪	<b>[RESET] button</b>	Resets deck functions to default settings.
⑫	<b>[PWR] button</b>	Turns deck power ON/OFF.
⑬	<b>[FM AM] button</b>	Switches to radio mode and switches radio bands.
⑭	<b>[AUDIO CONTROL] button</b>	Adjusts volume and performs other functions.
⑮	<b>Disc slot</b>	Inserts compact discs.
⑯	<b>Memory Stick slot</b>	Inserts and ejects Memory Stick.

\*: Double function button → "E-COM" & "MUTE" functions

# ***ESN security operating procedure***

## **About ESN**

This deck is equipped with ESN (ECLIPSE Security Network). A pre-registered music CD (Key CD), four-digit security code, or a Memory Stick on which a all unit functions will not operate, even by turning the ignition switch to the ACC or ON position or reconnecting the battery after turning the ignition switch off or disconnect the battery during maintenance.

ESN can be set or cancelled using any of the following methods:

- **Key CD security (See page 22)**

You can record a specific CD that you have as a "key CD" with the deck, and this CD can then be used to set and cancel the security settings.

- **Memory Stick security (See page 26)**

You can record a Memory Stick and a secret code (security code) with the deck, and this Memory Stick or secret code (security code) can then be matched with the deck to set and cancel the security settings.

- **ACC security (See page 36)**

This method can only be used when Memory Stick security has already been set. When ACC security is set, button operations are disabled when the ignition switch is turned to OFF and then back to ACC.



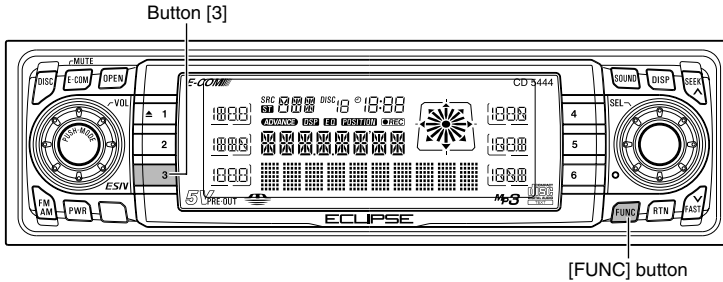

## How to switch the security type (Key CD security/Memory Stick security)

You can switch the type of security being used (Key CD security or Memory Stick security). The initial setting is for Key CD security to be used.

- 1** Check that the Power is OFF.
- 2** Press and hold button [3], then the [FUNC] button, and hold both for the more than two seconds.

Security type will switch from Key CD security (DISC SEC) ↔ Memory Stick security (MS SEC) in order each time the button is pressed.



If a security is activated, switching the security type is not available.

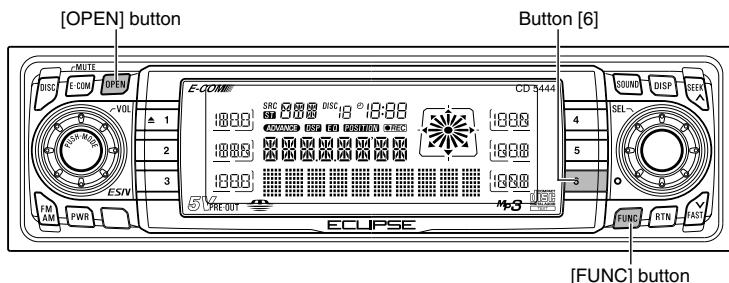

## How to operate the ESN (Key CD) security

### How to program the Key CD

- 1 Check that the Power is OFF.**
- 2 Press and hold button [6], then the [FUNC] button, and hold both for more than one second.**  
A [SEC] message appears, in two seconds it will change to [DISC].



- If a CD has already been inserted, a [SEC] message appears, and then the front panel opens and the CD is ejected.
- If a security is activated, programming the Key CD is not available.

- 3 Press the [OPEN] button.**  
The front panel opens; The CD5444 is now ready for your Key CD in the CD slot.
- 4 Insert the CD into the slot.**  
A [SEC] message appears, then the Key CD is ejected.
- 5 Press the [OPEN] button.**  
The front panel closes.



- If there is a problem with the inserted CD, an [ERR] message will appear for two seconds and the CD will be ejected. Reinsert the ejected CD.
- If a CD causes the [ERR] message to appear twice in a row, a [CHANGE] message will appear for two seconds. Try another CD.
- CD-R/RWs, CCCDs (Copy Control CDs) and MP3/WMA CD-ROM cannot be programmed for Key CD security.
- The Security indicator will flash whenever the vehicle's ignition is switched off.

## How to cancel the Key CD

- 1 Check that the Power is OFF.**
- 2 Press and hold button [6], then the [FUNC] button, and hold both for more than one second.**

A [SEC] message appears, then in two seconds it will change to [DISC].

- 3 Press the [OPEN] button.**

The front panel opens; The CD5444 is now ready to your Key CD in the CD slot.



If a CD has already been inserted, a [SEC] message appears, and then the front panel opens and the CD is ejected.

- 4 Insert your Key CD into the slot.**

A [CANCEL] message appears, then the Key CD is ejected.

The Key CD is cancelled.



- This process cancels the protection for ESN deck.
- If power to the ESN deck is disconnected, the reconnected, a Key CD will not need to be inserted in order to return the unit to normal operation.
- Inserting a CD other than the Key CD will not cancel the protection. Instead, the display [ERR] for two seconds, then the normal CD playback mode will activate.

- 5 Press the [OPEN] button.**

The front panel closes.

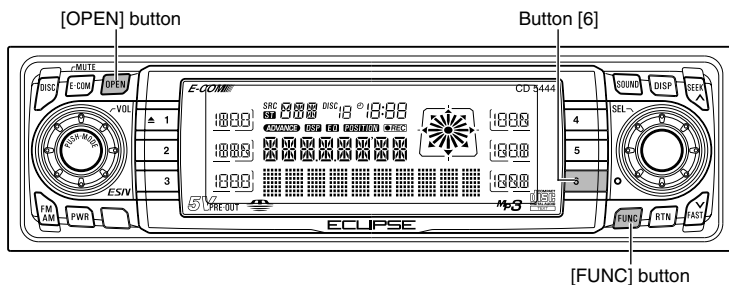

## How to change the Key CD

- 1 First, cancel the existing Key CD.**  
Refer to "How to cancel the key CD".
- 2 Next, program a new Key CD.**  
Refer to "How to program the Key CD".

## How to resume normal operation (ESN security lock out)

If power is disconnected while ESN security is active (a Key CD was programmed), operation is disabled until power is restored and the unit unlocked. Follow this procedure to resume normal operation.

- 1 When the power is turned on after disconnecting the battery power, a [SEC] message will appear for two seconds. Thereafter, message changed to [DISC] and the press the [OPEN] button, then the CD5444 is ready to accept your Key CD into the slot.**
- 2 Insert your Key CD.**  
If the correct CD is inserted, an [OK] message will appear for two seconds and the CD will begin playing.



- If the correct CD is inserted, an [ERR\_] ("ERR" and error number) message will appear for two seconds, after which the CD will be ejected.
- If [ERR5] (the 5th time an error has occurred) appears, [HELP] will appear, after which the CD will be ejected. When [HELP] appears, carry out the operations for an ESN security lock out by following the procedure in "What happens if an incorrect CD is inserted?" on page 25.
- You must be use the same CD used for Key CD programming; a duplicate CD may not work properly.

## What happens if an incorrect CD is inserted?

**1 After the 5th incorrect attempt, the display reads [HELP] for five seconds.**

After the [HELP] message will appear for five seconds, serial number will appear.

**2 Press button [6], then the [FUNC] button, and hold them for five seconds.**

After the [SEC] message will appear for two seconds, rolling code (six digit) will appear.

**3 Press [FUNC] button.**

A [DISC] message appears.

You will have five more attempts the correct disc.

**4 Insert the key CD into the slot.**

If the correct CD is inserted, an [OK] message will appear for two seconds and the CD will begin playing.



- If an incorrect CD is inserted, an [ERR\_] ("ERR" and error number) message will appear for two seconds, after which the CD will be ejected.
- This process cancels the protection for ESN deck.

### ● Note ●

If after 5 tries the correct Key CD is not inserted, the display reads [CALL800]; the unit must be returned to Eclipse to be reset. In this case, please contact your Eclipse dealer for assistance. For country-specific customer service information, refer to "How to contact customer service" on page 148.

Your Key CD can be easily forgotten. Write the album name in a reminder note (See page 151).

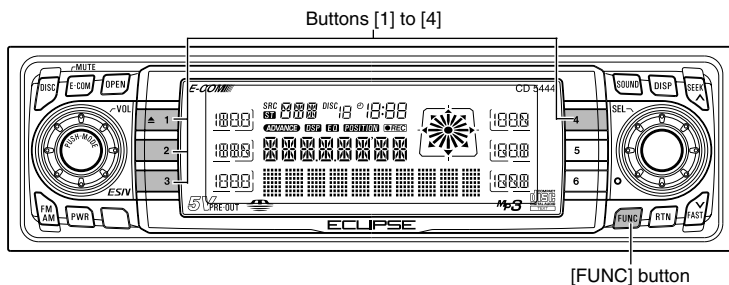

## How to operate the ESN (Memory Stick) security

### How to record a security code

- 1 Check that the Power is OFF.**
- 2 Press and hold button [1], then the [FUNC] button, and hold both for more than one second.**

A [SEC] message appears, in two seconds it will change to [MS].



- If a Memory Stick has already been inserted, a [MS EJECT] message appears. In this case, eject the Memory Stick and insert again. (Refer to "Ejecting the Memory Stick" on page 72 for details on ejection of the Memory Stick.)
- If a security is activated, recording the security code is not available.

- 3 Insert the Memory Stick into the slot.**  
A [- - -] (security code input display) appears.  
(Refer to "Listening to MG Memory Stick" on page 40 for details on insertion of the Memory Stick.)
- 4 Input a security code by pressing buttons [1] to [4].**  
Enter a four-digit security code using digits 0 to 9, A to F. The number (shown on the display) changes in ascending order between 0 and 9, A and F each time the button is pressed. Each button number (1 to 4) corresponds to each digit (first to fourth) of the security code.

**5 Press the [FUNC] button for more than one second.**

The security code is registered in the deck and security is set.

The registered security code is encrypted and then written to Memory Stick.



When the security code is registered using a Memory Stick that contains several kinds of data, such as music, etc., be careful not to clear the recorded data by formatting the Memory Stick.

**6 Eject the Memory Stick.**

Refer to "Ejecting the Memory Stick" on page 72.

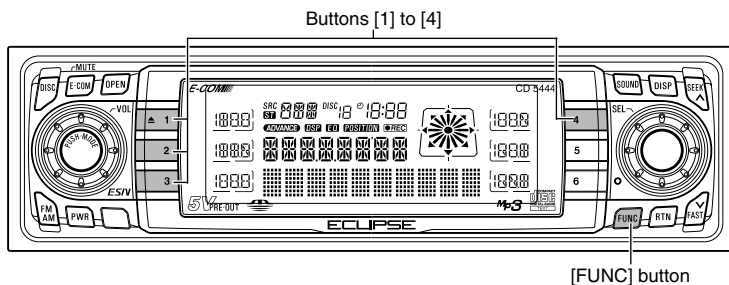

## How to cancel the Memory Stick security

The security function can be canceled when the security code that has been recorded with the deck is entered and verified. Canceling the security function can be done by entering the security code into the deck, or by using the Memory Stick.

### **Canceling the security function by entering the security code**

- 1 Check that the Power is OFF.**
- 2 Press and hold button [1], then the [FUNC] button, and hold both for more than one second.**  
A [SEC] message appears, then in two seconds it will change the [- - -] security code input display.
- 3 Input a security code by pressing buttons [1] to [4].**  
Enter a four-digit security code using digits 0 to 9, A to F. The number (shown on the display) changes in ascending order between 0 and 9, A and F each time the button is pressed. Each button number (1 to 4) corresponds to each digit (first to fourth) of the security code.
- 4 Press the [FUNC] button.**

If a security code is entered and the deck verifies that it is correct, [CANCEL] will appear on the display and the security function will be canceled.



If the security code that is entered does not match the code that is recorded by the deck, [ERR] will appear on the display for two seconds and operation will continue as normal without the security function being canceled.



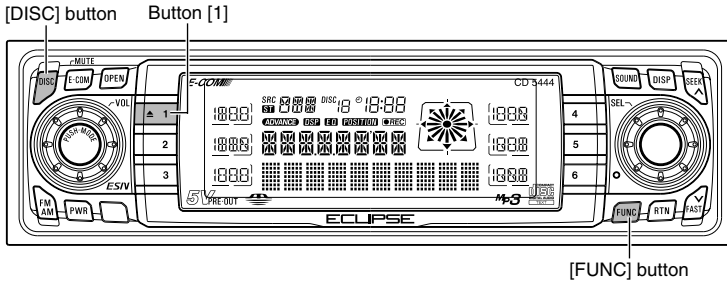

### **Canceling the security function using a Memory Stick**

- 1 Check that the Power is OFF.**
- 2 Press and hold button [1], then the [FUNC] button, and hold both for more than one second.**  
A [SEC] message appears, then in two seconds it will change the [- - -] security code input display.
- 3 Press the [DISC] button.**  
A [MS] message will appear. To change the [- - -] security code input display, press the [DISC] button again.



If a Memory Stick has already been inserted, a [MS EJECT] message appears. In this case, eject the Memory Stick and insert again. (Refer to "Ejecting the Memory Stick" on page 72 for details on ejection of the Memory Stick.)

**4 Insert the Memory Stick and close the front panel.**

The recorded data will be read from the Memory Stick.

**5 If the contents recorded in the Memory Stick match the information recorded by the deck, [CANCEL] will appear on the display.**

The security function will be canceled and the deck will return to normal operation.



- If a reading error occurs or if an incorrect Memory Stick is inserted, [ERR] will appear on the display for two seconds, and then the display will change to [EJECT]. If this happens, eject the Memory Stick and check it.
- Security setting cannot be canceled by this procedure if the Memory Stick containing the security code is formatted.

**6 Eject the Memory Stick.**

Refer to "Ejecting the Memory Stick" on page 72.

**How to change the Memory Stick**

You can change the Memory Stick and security code that have been recorded by the deck to a different Memory Stick and security code.

**1 Cancel the security code that has been recorded with the deck.**

Refer to "How to cancel the Memory Stick security" on page 28.

**2 Re-record the new Memory Stick and security code that you would like to use.**

Refer to "How to record a security code" on page 26.

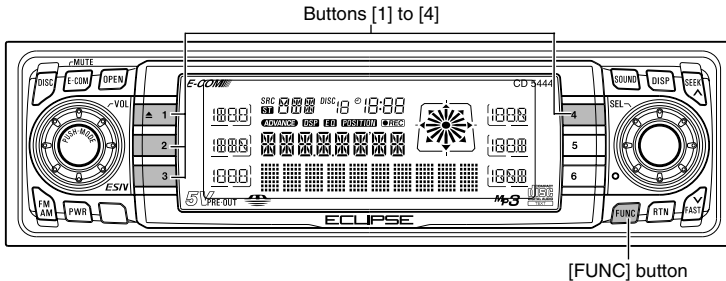

### How to resume normal operation (ESN security lock out)

If power is disconnected while ESN security is active (a security code was recorded), operation is disabled until power is restored and the unit unlocked. Follow this procedure to resume normal operation.

ESN security lock can be canceled by directly entering the security code into the deck, or by using the Memory Stick that was being used when the security code was recorded.

#### **Canceling ESN security lock using security code entry**

- 1** When the power is turned on after disconnecting the battery power, a [SEC] message will appear for two seconds. Thereafter, message changed to [- - -] security code input display.
- 2** Input a security code by pressing buttons [1] to [4].  
Enter a four-digit security code using digits 0 to 9, A to F. The number (shown on the display) changes in ascending order between 0 and 9, A and F each time the button is pressed. Each button number (1 to 4) corresponds to each digit (first to fourth) of the security code.

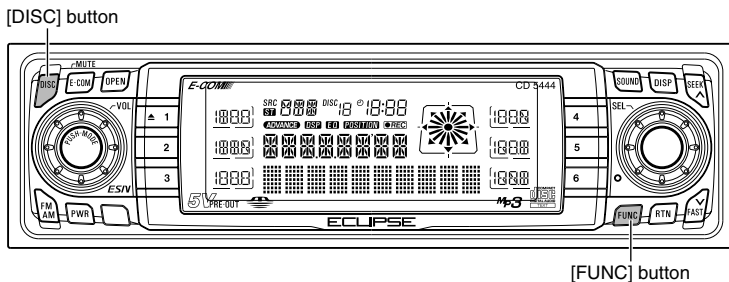

### 3 Press the [FUNC] button for more than one second.

If the security code matches the code recorded by the deck, [OK] will appear on the display and the security function will be canceled.



- If the security code does not match the information recorded by the deck, [ERR\_] (ERR and the error number) will appear on the display for two seconds, and then [- - -] (security code entry display) will appear. If this happens, check the security code and repeat the procedure from step 2.
- If [ERR5] (the 5th time an error has occurred) appears, [HELP] will appear. When [HELP] appears, carry out the operations for an ESN security lock out by following the procedure in "What happens if a Memory Stick or security code is incorrect?" on page 34.

### Canceling ESN security lock using Memory Stick

- 1 After the battery is connected and the deck's power is turned on, [SEC] will appear on the display for two seconds. After this, [- - -] (security code entry display) will appear.

- 2 Press the [DISC] button.

[MS] will appear on the display. If you press the [DISC] button once more, the display will return to [- - -] (security code entry display).



If a Memory Stick has already been inserted, a [MS EJECT] message appears. In this case, eject the Memory Stick and insert again. (Refer to "Ejecting the Memory Stick" on page 72 for details on ejection of the Memory Stick.)

**3 Insert the Memory Stick that has been recorded, and then close the front panel.**

The recorded data will read from the Memory Stick.

**4 If the contents recorded in the Memory Stick match the information recorded by the deck, [OK] will appear on the display for two seconds, and then the deck will return to normal operation.**



- If the contents recorded in the Memory Stick do not match the information recorded by the deck, [ERR\_] (ERR and the error number) will appear on the display for two seconds, and then [- - -] (security code entry display) will appear. If this happens, check the Memory Stick and repeat the procedure from step 2.
- If [ERR5] (the 5th time an error has occurred) appears, [HELP] will appear. When [HELP] appears, carry out the operations for an ESN security lock out by following the procedure in "What happens if a Memory Stick or security code is incorrect?" on page 34.
- ESN security lock cannot be canceled by this procedure if the Memory Stick containing the security code is formatted.

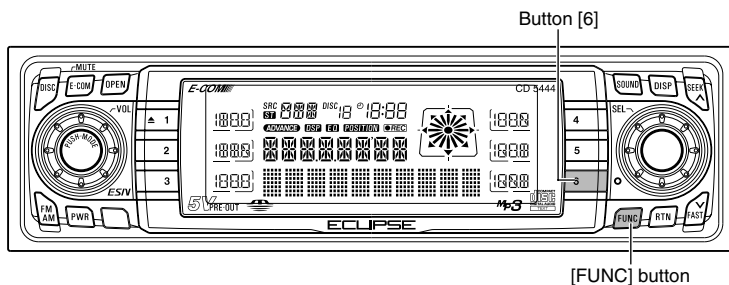

### What happens if a Memory Stick or security code is incorrect?

- 1 After the 5th incorrect attempt, the display reads [HELP] for five seconds.**

After the [HELP] message will appear for five seconds, serial number will appear.

- 2 Press and hold button [6], then the [FUNC] button, and hold both for more than one second.**

After the [SEC] message will appear for five seconds, rolling code (six digit) will appear.

- 3 Press the [FUNC] button.**

A [MS] message will appear. You will have five more attempts the correct Memory Stick.

- 4 Insert the Memory Stick that has been recorded, and then close the front panel.**

- 5 If the contents recorded in the Memory Stick match the information recorded by the deck, [OK] will appear on the display for two seconds, and then [EJECT] will appear. After you remove the Memory Stick, the deck will return to normal operation.**

If the recorded contents of the Memory Stick do not match the information recorded by the deck, [ERR\_] (ERR and the error number) will appear on the display, and then [EJECT] will appear. If this happens, eject the Memory Stick and try reinserting it.

**● Note ●**

If after 5 tries the correct Memory Stick is not inserted, the display reads [CALL800]; the unit must be returned to Eclipse to be reset. In this case, please contact your Eclipse dealer for assistance. For country-specific customer service information, refer to "How to contact customer service" on page 148.

Your security code and Memory Stick can be easily forgotten. Write the security code and Memory Stick title in a reminder note (See page 151).

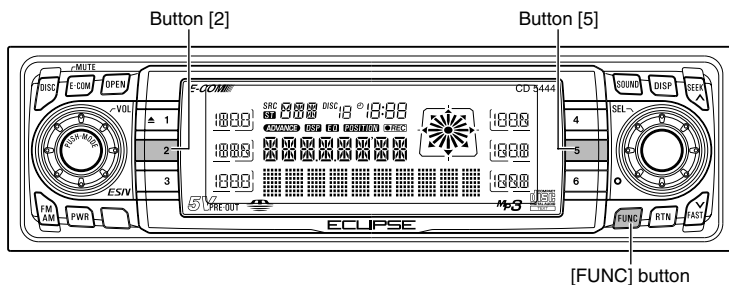

## How to operate the ACC security

ACC security involves using Memory Stick security to record a security code, and then when the ignition switch is turned to OFF and back to ACC, the operation of all buttons is disabled.

- 1** Check that the Power is OFF.
- 2** Once a security code has been recorded, press button [5] and the [FUNC] button simultaneously for more than two seconds.

The ACC security function will be activated. Press button [5] and the [FUNC] button simultaneously for two seconds or more again to cancel the ACC security function.



- If the vehicle's battery is disconnected at times such as during servicing, ACC security will be canceled.
- When ignition switch is turned OFF and back to ACC, the operation of all buttons is disabled. If this happens, resume normal operation. (Refer to "How to resume normal operation (ESN security lock out)" on page 31.)

## How to turn the security indicator on/off

Once ESN security is activated, the indicator flashes whenever the vehicle's ignition switch is turned off, warning potential thieves that the unit is protected. However, if do not want this visible deterrent, it may be turned off.

- 1** With the power OFF, press button [2], then [FUNC] button and hold both for more than one second.
- 2** [IND. FLASH] or [IND.-----] appears on the display.

[IND. FLASH] means the security indicator will flash when the vehicle's ignition switch is off, and [IND.-----] means it will not. Repeat the above steps to reactivate the flash mode.



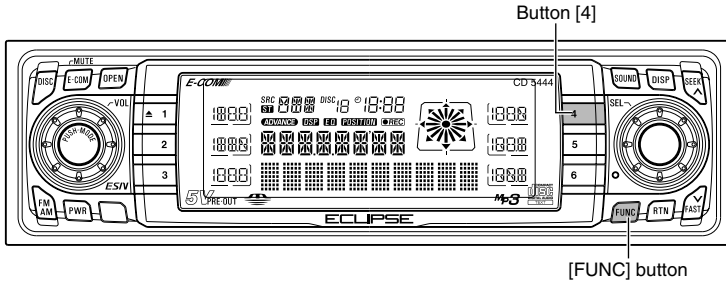

## How to read the Electronic Serial Number

- 1** Check that the Power is OFF.
- 2** Press and hold button [4], then the [FUNC] button, and hold both for more than one second.

[ESN] appears on the display, followed by an eight-digit number; this number is your electronic serial number (ESN). You may use this number to identify your Eclipse CD5444 in the event it recovered after being stolen.

# Basic operation

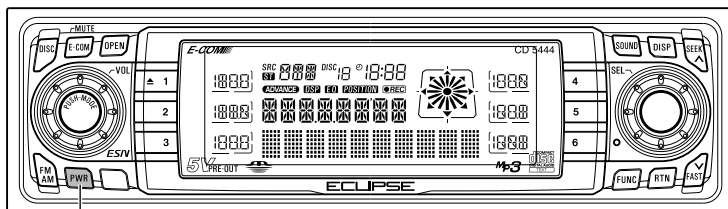

[PWR] button

This section covers basic operating procedures. For additional details, please refer to the sections on specific functions.

## Turning the power on and off

Turning the power on and off.

When the power is turned on, the state used when the power was turned off such as CD and tuner playing is restored.

When the vehicle has no ACC position on the ignition switch, care is needed when turning off the deck. Follow Step 2 or Step 3 when turning off the power.

### 1 When power is OFF, press [PWR] button.

The power will come ON.



When the deck's power is turned on for the first time or if the battery terminals have been disconnected because of a reason such as vehicle maintenance and the power is then turned back on, the deck will start up in FM1 mode. After this, the broadcast stations will be searched for automatically and stored in buttons [1] to [6].

### 2 When power is ON, press the [PWR] button for less than two seconds.

The power will go OFF and the deck will be in Standby.

If you press the [PWR] button again for more than one second, the power will go completely off.

### 3 When power is ON, press the [PWR] button for more than two seconds.

The power will go completely OFF.



If a car is not equipped with an ACC position (for example, a European car), press the [PWR] button for more than two seconds.

[DISC] button [OPEN] button

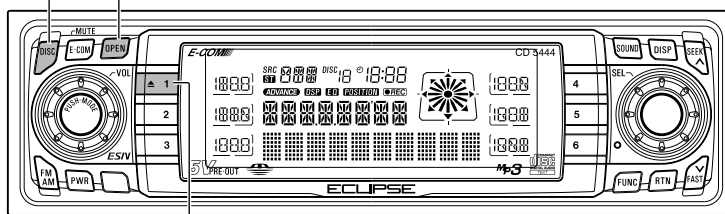

Button [1]

## Listening to a CD

- 1 Press the [OPEN] button.

The front panel opens.

- 2 Insert a CD into the disc slot, label side up.

The CD will immediately start playing.

When press the button [1], CD is ejected.



- A CD cannot be ejected when the front panel is closed, even after pressing button [1].
- When a CD is already loaded, press the [DISC] button to switch to the CD mode.



Do not press the [OPEN] button while CD is being inserted. This could cause an injury and damage to the front panel.

- 3 Press the [OPEN] button.

The front panel closes.

[DISC] button [OPEN] button

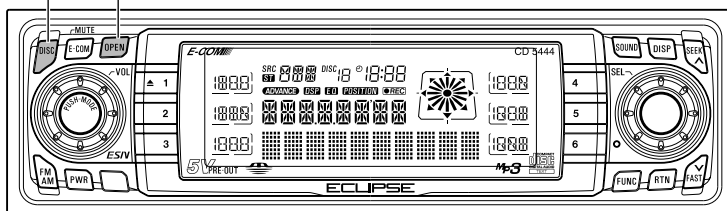

## Listening to MG Memory Stick

- 1 Press the [OPEN] button.

The front panel opens.

- 2 Insert a MG Memory Stick into the Memory Stick slot.



ATTENTION

- Insert the MG Memory Stick with the mark facing inwards and press MG Memory Stick into place until a clicking sound is heard. Do not press forcefully when the MG Memory Stick makes contact with the internal stopper because it cannot be inserted any further. (The MG Memory Stick should be protruding a few millimeters from the Memory Stick slot.)
- Use a Memory Stick Duo adapter when inserting the Memory Stick Duo. (If the Memory Stick Duo is inserted without the adapter, it will not be ejected from the unit.)
- When the MG Memory Stick is already loaded, press the [DISC] button to switch to the Memory Stick mode.



Warning

Do not press the [OPEN] button while the MG Memory Stick is being inserted. This could cause an injury and damage to the front panel.

- 3 Press the [OPEN] button.

The front panel closes.

- 4 Press the [DISC] button to switch to the Memory Stick mode.

MG Memory Stick will start playing.

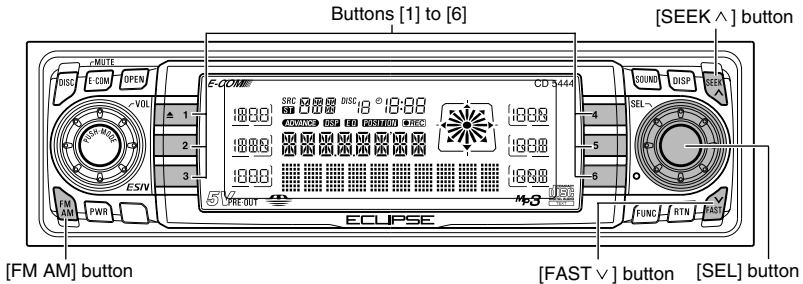

## Listening to the tuner

- 1 Press the [FM AM] button.

This will turn the tuner on.

- 2 Press the [FM AM] button to switch to the desired FM or AM bands.

Radio bands will switch from FM1 → FM2 → FM3 → AM in order each time the button is pressed.

- 3 Turn the [SEL] button to the left or right to tune to a station.

Turn to the right: Tunes to higher frequencies.

Turn to the left: Tunes to lower frequencies.

- 4 Press the [SEEK ^ / FAST v] button to start the automatic station search.

[SEEK ^] button: Starts searching toward higher frequencies.

[FAST v] button: Starts searching toward lower frequencies.



If stations have been stored in memory, pressing a button from [1] to [6] will directly select a station. (Refer to the section “Manually setting stations into memory” on page 80)

[E-COM] button

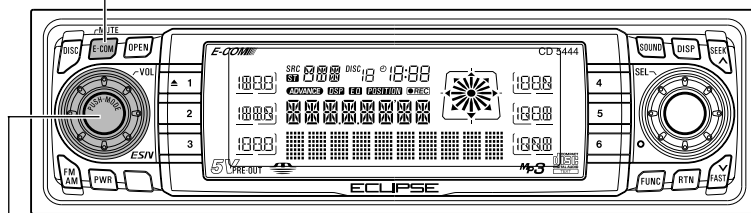

[AUDIO CONTROL] button

## Adjusting audio volume

- 1 Turn the [AUDIO CONTROL] button to the left or right.

Turn to the right: Increases the volume.

Turn to the left: Decreases the volume.



ATTENTION

Press the [E-COM] button for more than one second if E-COM is connected and less than one second if E-COM is not connected to cut the volume or restore it instantly.



Warning

Do not adjust the volume or other controls while driving the vehicle. Do so only while parked in a safe location.

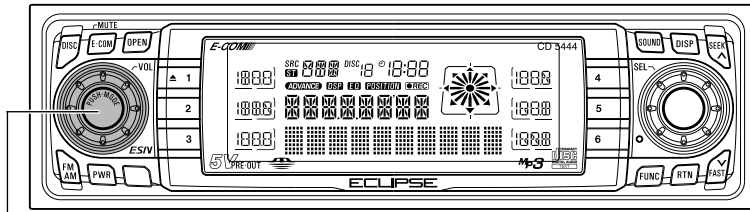

[AUDIO CONTROL] button

## Switching audio control modes

Various audio control modes may be fine-tuned using this procedure.

- 1 Press the [AUDIO CONTROL] button for less than one second to select the item to be adjusted.

Modes will switch in the order shown below each time the button is pressed.

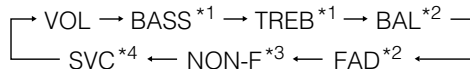

\*1: When the sound adjustment mode is in normal mode, this adjustment is not available. (Refer to page 96.)

\*2: If the position selector is "ON", this adjustment is not available. (Refer to page 98 and 107.)

\*3: NON-FADER output does not reflect BASS, TREBLE, LOUDNESS and EQUALIZER settings.

\*4: Setting cannot be made in FM mode.

### VOL (VOLUME) Mode

Adjusts volume.

Turn the [AUDIO CONTROL] button to the left or right.

Turn to the right: Increases the volume.

Turn to the left: Decreases the volume.

### BASS Mode

Adjusts bass level. Bass mode can be adjusted for each source (CDP/CDC, Memory Stick, FM and AM).

Turn the [AUDIO CONTROL] button to the left or right.

Turn to the right: Emphasizes low sounds.

Turn to the left: Softens low sounds.

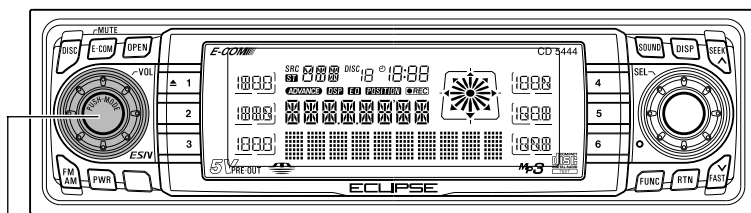

[AUDIO CONTROL] button

### TREB (TREBLE) Mode

Adjusts treble level. Treble mode can be adjusted for each source (CDP/CDC, Memory Stick, FM and AM).

Turn the [AUDIO CONTROL] button to the left or right.

Turn to the right: Emphasizes high sounds.

Turn to the left: Softens high sounds.

### BAL (BALANCE) Mode

Adjusts left/right speaker balance.

Turn the [AUDIO CONTROL] button to the left or right.

Turn to the right: Emphasizes right speakers.

Turn to the left: Emphasizes left speakers.

### FAD (FADER) Mode

Adjusts front/rear speaker balance.

Turn the [AUDIO CONTROL] button to the left or right.

Turn to the right: Emphasizes front speakers.

Turn to the left: Emphasizes rear speakers.

### NON-F (NON-FADER) Mode

Adjusts non-fader level (for connected sub-woofers, etc.).

Turn the [AUDIO CONTROL] button to the left or right.

Turn to the right: Increases level.

Turn to the left: Decreases level.



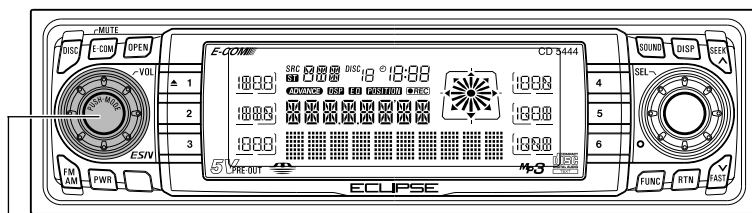

[AUDIO CONTROL] button

## SVC (Source Volume Control) Mode

You can set different volume levels for each audio mode. The volume for the initial FM mode (default value: 40) is used as a reference for storing the differences in volume that have been set for each audio mode. When SVC is set, the volume level can change as shown in the example settings in the table below.

### Setting examples:

Audio mode	FM	AM	CD	Memory Stick
Default value (Volume level)	Reference (40)	0 (40)	0 (40)	0 (40)
SVC setting (Volume level)	Reference (40)	SVC setting value +15 (55)	SVC setting value -10 (30)	SVC setting value +5 (45)
When volume level in FM mode is adjusted from 40 to 45	45	55 → 60	30 → 35	45 → 50
When volume level in CD mode is adjusted from 35 to 60	45 → 70	60 → 80*	60	50 → 75
When volume level in AM mode is adjusted from 80 to 20	70 → 5	20	60 → 0*	75 → 10
When volume level in Memory Stick mode is adjusted from 10 to 35	5 → 30	20 → 45	0 → 20	35

\*: The volume levels can be set to a maximum of 80 and a minimum of 0. If you try to go past the maximum or minimum volume level, the level will not change. For the CD changer, SVC adjusts the volume using the setting value for the CD player.

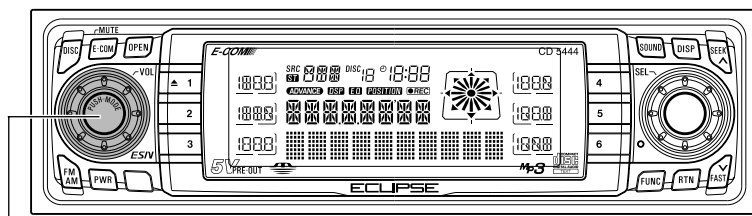

[AUDIO CONTROL] button

Turn the [AUDIO CONTROL] button to the left or right.  
 Turn to the right: Increases the SVC setting value.  
 Turn to the left: Decreases the SVC setting value.  
 The volume difference can be set within a range of -10 to +20.



If the battery terminals have been disconnected because of a reason such as vehicle maintenance, the SVC settings will return to their default values. If this happens, you will need to make the settings again.

## Enabling the loudness control

The loudness control may be turned on to emphasize low and high frequencies at low volume levels.

Loudness compensates for the apparent weakness of low and high frequencies at low volume by boosting the bass and treble levels.

- 1 Press and hold the [AUDIO CONTROL] button until the [LOUD ON] display appears on the screen.



To disable the loudness feature, repeat the above procedure to display the [LOUD OFF] indication.

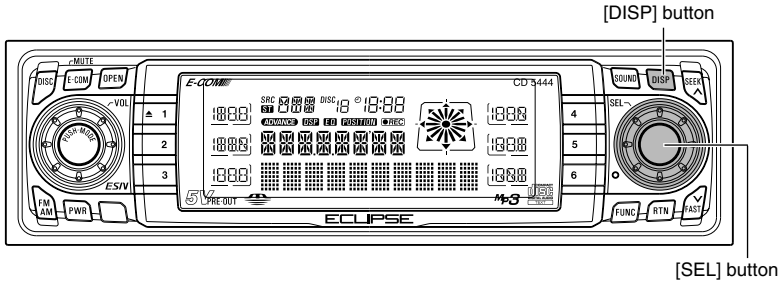

## Making changes with Display Adjustment Mode

This function allows adjustment of display contrast and changing illumination colors.

- 1 Press the [DISP] button for less than one second.

The display adjustment mode is activated.

- 2 Turn the [SEL] button in either direction to display setting items for selection.

When the button is turned, the setting item changes in the following order.

CONTRAST ↔ ILL COLOR

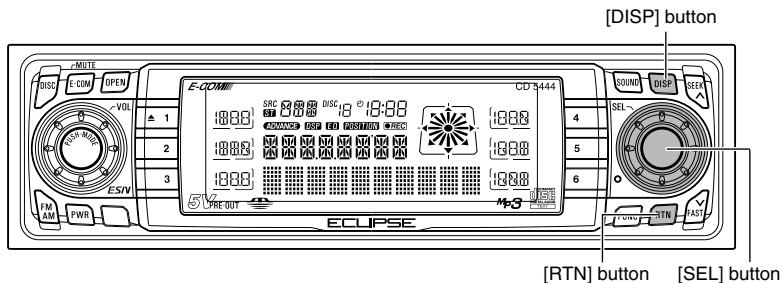

### Contrast adjustment

Adjust the display contrast to the best level in accordance with the angle of viewing.

**1 Turn the [SEL] button to select CONTRAST.**

**2 Press the [SEL] button.**

Enters contrast adjustment mode.

**3 Turn the [SEL] button to adjust contrast.**

When the button is turned, the contrast level changes in the following order.

→ (Level) 1 ↔ 2 ↔ 3 ↔ 4 ↔ 5 →

**4 Press the [RTN] button.**

At this time, other adjustments can also be made in display adjustment mode.

**5 Press the [DISP] or [RTN] button to exit display adjustment mode.**

### Changing illumination Color

**1 Turn the [SEL] button to select ILL COLOR.**

**2 Press the [SEL] button.**

The screen for changing the illumination color will appear.

**3 Turn the [SEL] button to select GREEN or RED.**

**4 Press the [RTN] button.**

At this time, other adjustments can also be made in display adjustment mode.

**5 Press the [DISP] or [RTN] button to exit display adjustment mode.**



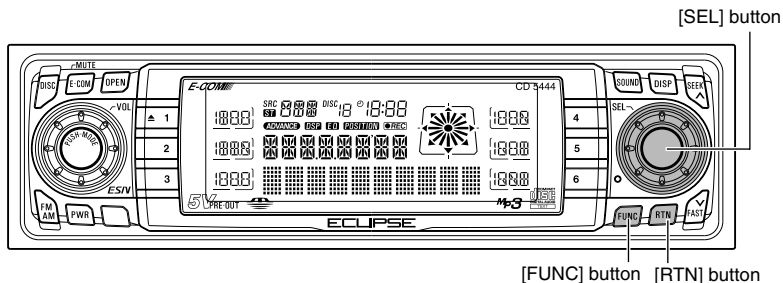

### Disabling the guide tone feature (for button operation)

The receiver is set at the factory to emit a beep tone in response to button operation. The guide tone feature may be disabled in the following procedure:

- 1 Turn the [SEL] button to select GUIDE TONE.**
- 2 Press the [SEL] button.**  
The Guide Tone Mode will be switched ON/OFF.
- 3 Turn the [SEL] button to select ON or OFF.**
- 4 Press the [RTN] button.**  
At this time, other adjustments can also be made in function mode.
- 5 Press the [FUNC] or [RTN] button to exit function mode.**

### Clock display on/off

Switches the clock display to ON/OFF.

- 1 Turn the [SEL] button to select CLOCK DISP.**
- 2 Press the [SEL] button.**  
The clock display ON/OFF mode is activated.
- 3 Turn the [SEL] button to select ON or OFF.**
- 4 Press the [RTN] button.**  
At this time, other adjustments can also be made in function mode.
- 5 Press the [FUNC] or [RTN] button to exit function mode.**

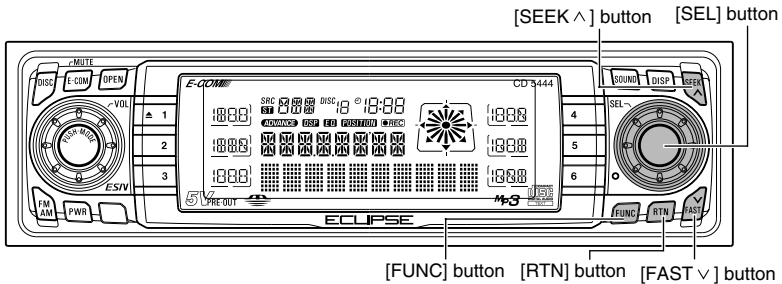

## Setting the Time

This receiver uses the 12-hour display notation.

**1 Turn the [SEL] button to select CLOCK ADJ.**

**2 Press the [SEL] button.**

The clock adjustment mode is activated.

**3 Turn the [SEL] button to display the item to be selected for adjustment.**

Hours, minutes or exact hour will be switched each time the button is turned.

**4 Press the [SEEK ^ /FAST v] button.**

[SEEK ^] button: Turns the time forward.

[FAST v] button: Turns the time back.

To set the clock to 0 minutes, 0 seconds (an exact hour), press the [SEEK ^ /FAST v] button.

For example:

At 3:29: Pressing the [SEEK ^ /FAST v] button returns to 3:00.

At 3:30: Pressing the [SEEK ^ /FAST v] button advances to 4:00.

**5 Press the [RTN] button.**

At this time, other adjustments can also be made in function mode.

**6 Press the [FUNC] or [RTN] button to exit function mode.**

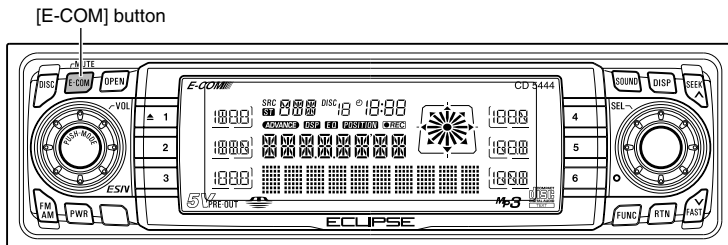

## Others

### Enabling E-COM feature

- 1 Press the [E-COM] button for more than one second.  
Pressing the button will switch the E-COM feature on or off.

### Operation assist function

Buttons to be used will flash and operation order will be shown when in display adjustment mode, function mode or sound adjustment mode.



## How to operate the CD player

[DISC] button

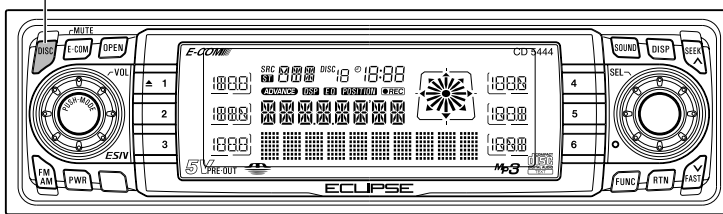

First press the [DISC] button to switch to the disc mode. It is assumed here that a CD has already been loaded into the unit.

## Listening to CDs

- 1 Press the [DISC] button to switch to the CD player mode.

This starts CD play.

Disc mode will switch from CD player → Memory Stick player in order each time the button is pressed.

If an external CD changer is connected, each additional press of the [DISC] button will switch modes from CD changer 1 → CD changer 2 → Memory Stick player → CD player.

A changer or player with no discs loaded will be skipped.



Caution

- Playback may be intermittent when there is a scratch on a CD or when the recorded side is dirty.
- Only two external CD changers may be connected.

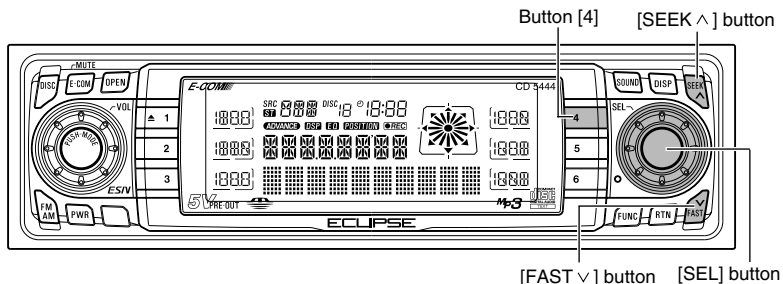

## Advancing to the next track or returning to the beginning of the track being played

- 1 Turn the [SEL] button to the left or right.

Turn to the right: Advances to the next track.

Turn to the left: Returns to the beginning of the track being played. (Repeat turning for previous tracks.)

## Fast Forward/Rewind

Fast forward or rewind the song currently being played.

- 1 Press and hold the [SEEK ^] or [FAST v] button.

[SEEK ^] button: Fast forward.

[FAST v] button: Rewind.

## Playing the beginning of tracks (SCAN)

- 1 Press button [4].

Pressing the button causes the player to move up to the next track and play it for 10 seconds, then move up to the next track and play it for 10 seconds, and so on until the button is pressed again.



- To continue playing a desired track, press the button again to stop scanning.
- After the entire disc is scanned once, ordinary playback starts from the point where scanning started.

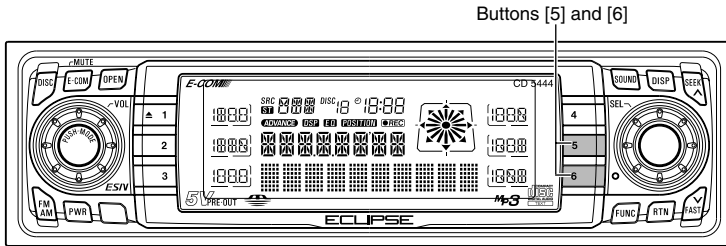

## Repeating the same track (REPEAT)

- 1 Press button [5] to repeat the track being played.

To cancel, press button [5] again.

## Playing tracks in random order (RANDOM)

- 1 Press button [6] to play the tracks in random order.

To cancel, press button [6] again.



- During random playback, press button [5] to repeat the track being played. To cancel repeat play (go back to random play), press button [5] again.

During playback of a particular track: The track being played is played repeatedly.

While searching: The following track is played repeatedly.

- Occasionally the same track happens to be played (selected) two or more times in a row; this is normal operation and is no sign of a problem.
- When any of the functions - "Playing the beginning of tracks," "Repeating the same track" and "Playing tracks in random order" - is selected, a message such as [SCN], [RPT] or [RAND] appears on the display to verify the current function.

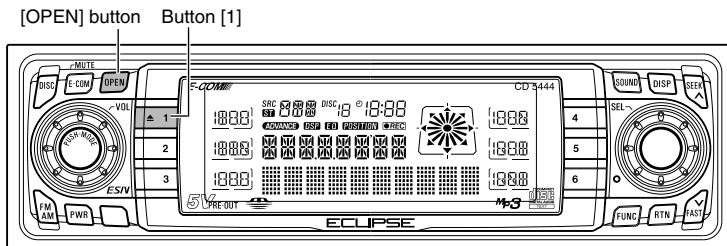

## Ejecting the disc

- 1** Press the [OPEN] button for less than one second.

The front panel opens.

- 2** Press the button [1].

Disc is ejected.

- 3** Remove the disc and press the [OPEN] button.

The front panel closes. If left alone for 15 seconds after the disc ejection, the front panel closes after the BEEP sound.



Caution

- Do not drive with the front panel open. The panel may cause unexpected personal injury during a panic stop, or the like.
- Do not attempt to close the front panel by hand. Doing so may damage the panel.

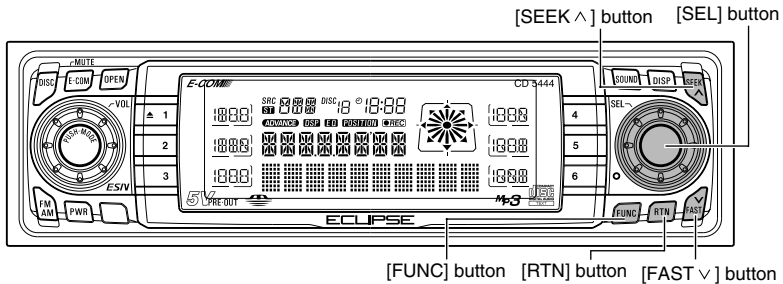

## Creating a title for a CD

A CD title may be created, attached and displayed for your discs. If external CD changers are connected, a title for a CD will be created in the same way. It is assumed here that the CD to be titled is playing.



No CD text disc can be set.

- 1 Press the [FUNC] button for less than one second while in the Disc mode.
- 2 Turn the [SEL] button to select DISC TITLE.
- 3 Press the [SEL] button.

The disc title setting mode is activated.

- 4 Press the [SEEK ^] button to select the character type.

Pressing the button will switch types from [ABC] (alphabet characters) to [123] (numeric characters) and then [!&?] (symbols).

- 5 Press either [SEL] or [FAST v] button to select the position in which to enter the character.

The character will be inserted where the cursor is flashing:

[SEL] button: Moves the cursor to the right.

[FAST v] button: Advances the cursor to the left.

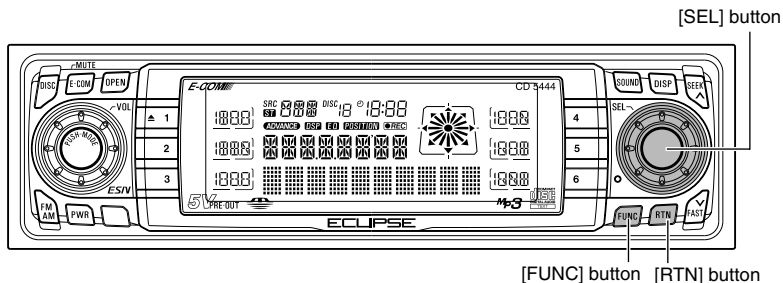

**6** Turn the [SEL] button to the left or right to select characters.

Turn to the right: Advances the character forward in its type.  
 Turn to the left: Moves the character backward in its type.

- [Upper-case alphabet characters] Initial value [A] [Right direction]  
 →A→B→C→…→X→Y→Z→
- [Numeric characters] Initial value [1] [Right direction]  
 →1→2→3→…→8→9→0→
- [Symbol] Initial value [!] [Right direction]  
 →!→"→#→\$→%→&→'→(→)→\*→+→,→-→.→/→:→;→<→=→>→?→@→'→\_→



- To change the type of character to be entered, repeat steps 3 and 4.
- A maximum of 12 characters may be entered per title.
- 30 titles can be stored.
- If the number of discs that can be memorized is exceeded, the information about the disc whose playing time is oldest is deleted.

**7** Press the [RTN] button.

At this time, other adjustments can also be made in function mode.

**8** Press the [FUNC] or [RTN] button to exit function mode.

The CD title is now memorized.

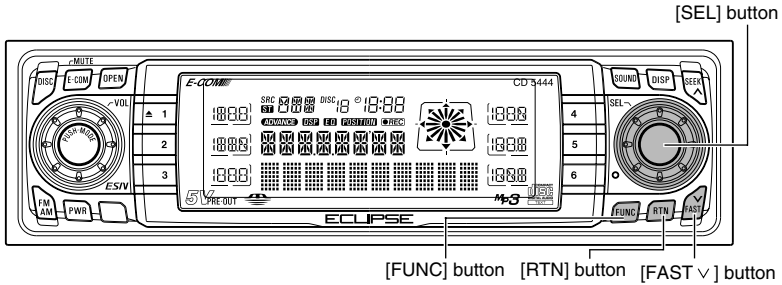

## Changing a previously set title

If external CD changers are connected, a previously set title for a CD will be changed in the same way. It is assumed here that the disc mode is selected.

**1** Press the [FUNC] button for less than one second while in the Disc mode.

**2** Turn the [SEL] button to select DISC TITLE.

**3** Press the [SEL] button.

The disc title setting mode is activated.

**4** Press either [SEL] or [FAST ∨] button to move the cursor to the position in the title for inserting or changing characters.

[SEL] button: Moves the cursor to the right.

[FAST ∨] button: Advances the cursor to the left.

**5** Turn the [SEL] button to the left or right to select characters.

Turn to the right: Advances the character forward in its type.

Turn to the left: Moves the character backward in its type.



To leave a space blank, follow these steps.

1. Select and flash the space to be blank.
2. Turn the [SEL] button to make a blank space flashing.
3. Press the [SEL] button to move.

**6** Press the [RTN] button.

At this time, other adjustments can also be made in function mode.

**7** Press the [FUNC] or [RTN] button to exit function mode.

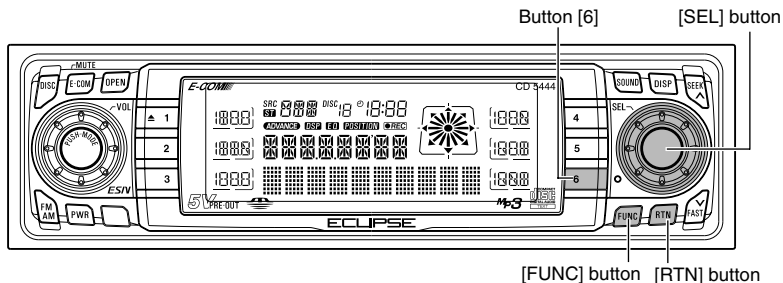

## Deleting a previously created title

If external CD changers are connected, a previously created title for a CD will be deleted in the same way. It is assumed here that the disc mode is selected.

- 1** Press the [FUNC] button for less than one second while in the Disc mode.
- 2** Turn the [SEL] button to select DISC TITLE.
- 3** Press the [SEL] button.  
The CD title being played at this point will be deleted.
- 4** Hold button [6] down for more than two seconds.  
The title has now been deleted.
- 5** Press the [RTN] button.  
At this time, other adjustments can also be made in function mode.
- 6** Press the [FUNC] or [RTN] button to exit function mode.



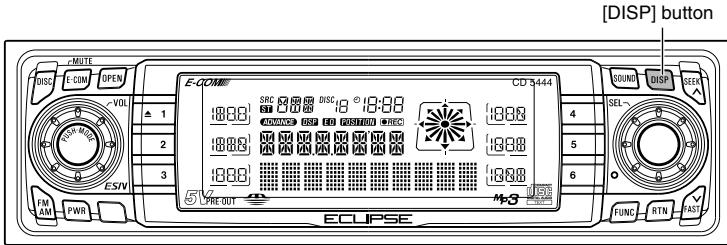

## Displaying CD TEXT

Only the built-in CD player supports CD TEXT. It can not be displayed with the optional CD changer. If the CD came with a logo shown below, it is recorded with a disc title and track titles. These information will be displayed during playback.



- 1 Press the [DISP] button for more than one second.

Pressing the [DISP] button while text is displayed scrolls the display in the order DISC title → TRACK title, and then the display stops with the TRACK title.

# How to operate the MP3 player

## About MP3



The making of MP3 files by recording from sources such as broadcasts, records, recordings, videos and live performances without permission from the copyright holder for uses other than personal enjoyment is prohibited.

### What is MP3?

MP3 (MPEG Audio Layer III) is a standard format for audio compression technology. By using MP3, a file can be compressed to one-tenth the size of the original.

This deck has limitations on MP3 file standards and recorded media and formats that can be used.

### Playable MP3 file standards

- Supported standards: MPEG-1 Audio Layer III, MPEG-2 Audio Layer III
- Supported sampling frequencies: 44.1, 48 (kHz)
- Supported bit rate: 64, 80, 96, 112, 128, 160, 192, 224, 256, 320 (kbps)
  - \* Supports VBR. (64~320kbps)
  - \* Does not support free format.
- Supported channel modes: stereo

### ID3 tags

MP3 files have an "ID3 Tag" that allows input of information so that data such as song title and artist can be saved.

This deck supports ID3v.1.0, ID3v1.1 and ID3v2\* tags.

\*: If the ID3v2 tag is present, the ID3v1.0 or ID3v1.1 tag will have priority.

## Media

Media capable of playing MP3 includes CD-R and CD-RW discs. Compared to CD-ROM media commonly used for music discs, CD-R discs are fragile in high temperature/high humidity environments and one section of the CD-R may become incapable of playback. Fingerprints or scratches on the disc may prevent playback or cause skipping during playback. Sections of a CD-R may deteriorate if left inside a vehicle for long periods of time. It is also recommended that CD-R discs be kept in a light-blocking case because the discs are vulnerable to ultra-violet light.

## Format of discs

The format of discs to be used must be ISO9660 Level 1 or Level 2.

Control items for this standard are as follows:

- Maximum directory layers: 8 layers
- Maximum characters for folder names/file names: 32 (including "." and 3 letter file extension)
- Allowable characters for folder names/file names: A~Z, 0~9, \_ (underscore)
- Number of files/folders possible on a single disc: 512

[Configuration example for CD supporting MP3]

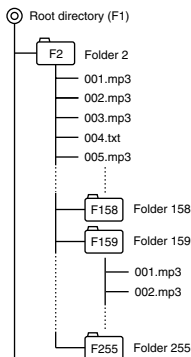

Number of files/folders possible on a single disc is 512.

Files aside from MP3 files (Example: 004.txt) also count as single files.

- Total number of folders possible on a single disc: 255
- Maximum folders this deck can recognize: 256\*

\*: A root directory is counted as one folder.

## File names

Only files with the MP3 file extension ".mp3" can be recognized as MP3 and played. Be sure to save MP3 files with the ".mp3" file extension. The "MP" letters of the file extension will be recognized whether entered as uppercase letters or lowercase letters.



If the ".mp3" file extension is attached to a file other than an MP3 file, that file will be mistakenly recognized by the deck as an MP3 file and played, resulting in loud noise output that can damage the speakers. Be sure to avoid attaching the ".mp3" file extension to files that are not MP3 files.

## Multi-sessions

Multi-sessions are supported, and playing of CD-R and CD-RW discs with annotated MP3 files is possible. However, when "Track at once" has been written, close the session or process the warning message. Standardize the format of each session without changing the format.

## Playing MP3

When a disc with recorded MP3 files is inserted, the deck first checks all the files on the disc. No sound is output while the deck is checking the files on the disc. It is recommended that the disc be recorded without files other than MP3 files and without unnecessary folders in order to speed up the checking of disc files by the deck.

## MP3 playing time display

It is possible that playing time will not be correct, depending on the writing condition of the MP3 file.

\* It is possible that playing time will not be correct when VBR Fast Up/Down is operated.

## Display order of MP3 file/folder names

Names of MP3 folders and files within the same level are displayed in the following order.

1. MP3 folders displayed first, by ascending order of numbers, letters.
2. Files displayed next, by ascending order of numbers, letters.

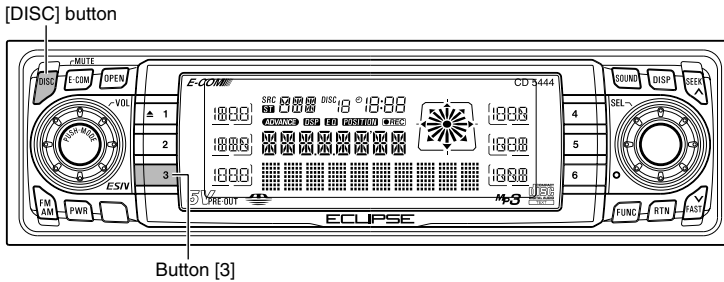

## Listening to MP3 file

- 1 Press the [DISC] button to switch to the CD player mode.

This starts MP3 file play.

Disc mode from CD player → Memory Stick player in order each time the button is pressed.

If an external CD changer is connected, each additional press of the [DISC] button will switch modes from CD changer 1 → CD changer 2 → Memory Stick player → CD player.

A changer or player with no discs loaded will be skipped.



- Playback may be intermittent when there is a scratch on a CD or when the recorded side is dirty.
- Only two external CD changers may be connected.

### ● Note ●

When music data recorded in the normal way (CD-DA) is present on the same disc with MP3 music files, the normally recorded music data will be played. To listen to the MP3 music files, press button [3] for more than one second.

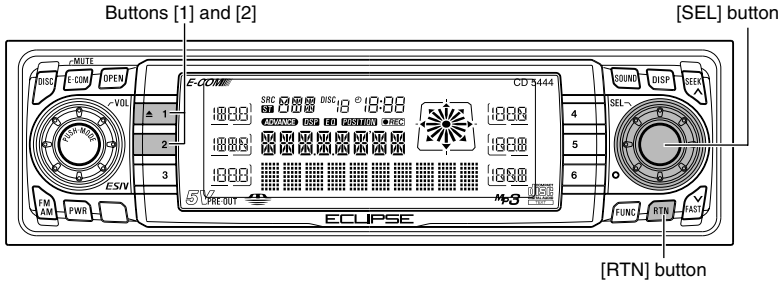

## Advancing to the next track (file) or returning to the beginning of the track (file) being played

- 1 Turn the [SEL] button to the left or right.

Turn to the right: Advances to the next track (file).

Turn to the left: Returns to the beginning of the track (file) being played.

Repeat turning for previous tracks (files).

## Skipping to the next or previous folder

- 1 Press button [1] or [2].

Button [1]: Selects the next folder.

Button [2]: Selects the next lower folder.

## Return to the root directory of the CD

In the root directory, when a file cannot replay, the system will return to the first file that can perform a replay. (In the configuration example, the file is returning to 001.mp3. See page 63.)

- 1 Press the [RTN] button.

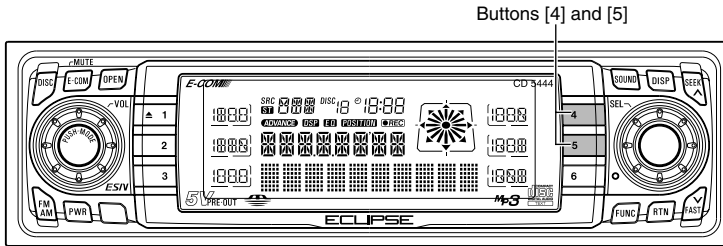

## Playing the beginning of files (SCAN)

**1** Press button [4].

Press the button briefly to play just the first 10 seconds of each song for all the files in the same layer of the folder being played.

Pressing the button until [FOLD SCAN] is displayed will play just the first 10 seconds of the first song in each folder.



- To continue playing a desired file, press the button again to stop scanning.
- After the entire disc is scanned once, ordinary playback starts from the point where scanning started.

## Repeating the same file (REPEAT)

**1** Press button [5].

Press the button briefly to repeat the file being played.

Pressing the button until [FOLD RPT] is displayed will repeat all the files in the same layer as the folder being played.

To cancel, press button [5] again.

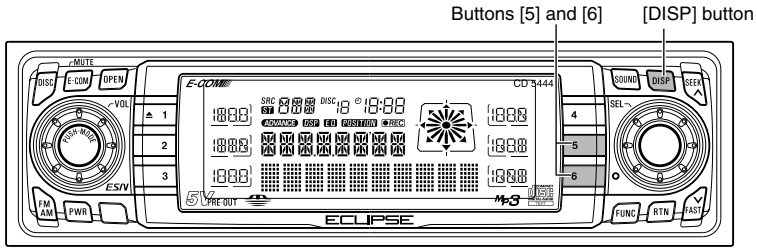

## Playing files in random order (RANDOM)

### 1 Press button [6].

Press the button briefly to randomly play the files in the same layer as the folder being played.

Pressing the button until [ALL RANDOM] is displayed will randomly play the files in all the folders.

To cancel, press button [6] again.



- During random playback, press button [5] to repeat the file being played. To cancel repeat play (go back to random play), press button [5] again.

During playback of a particular file: The file being played is played repeatedly.

While searching: The following file is played repeatedly.

- Occasionally the same file happens to be played (selected) two or more times in a row; this is normal operation and is no sign of a problem.

## Displaying title

### 1 Press the [DISP] button for more than one second.

Each time the button is pressed, the following will be displayed in order.

Folder Name/File Name\* → Tag

\*: The display area shows a maximum of 10 characters and then scrolls to display the remaining characters. After the folder name is displayed, the file name will be displayed by scrolling. After the file name is scrolled, the display will be fixed.



## How to operate the Memory Stick player

Music data recorded on "MG Memory Stick" with ATRAC3 (an audio compression technology) can be played on this deck. Recording from music CD to the MG Memory Stick is also possible. The following explanation for the operation is made assuming that the MG Memory Stick has already been inserted.

First press the [DISC] button to switch to the disc mode. It is assumed here that a MG Memory Stick has already been loaded into the deck.



- Artist name and music title (track titles) can be displayed when they are recorded on the MG Memory Stick. A maximum of 10 characters (1 byte alphabets, numeric or symbols) can be displayed.
- Music data recorded with MP3 and ATRAC3 Plus cannot be played.

[DISC] button

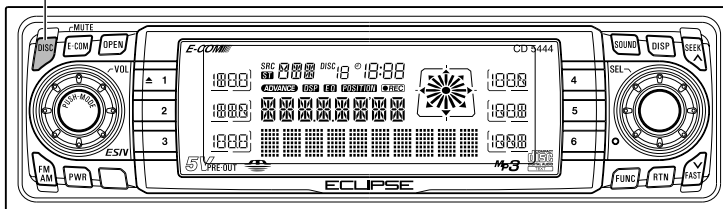

## Listening to MG Memory Stick

- 1 Press the [DISC] button to switch to the Memory Stick player mode.

Disc mode will switch from CD player → Memory Stick player in order each time the button is pressed.

If an external CD changer is connected, each additional press of the [DISC] button will switch modes from CD changer 1 → CD changer 2 → Memory Stick player → CD player.

A changer or player with no discs loaded will be skipped.

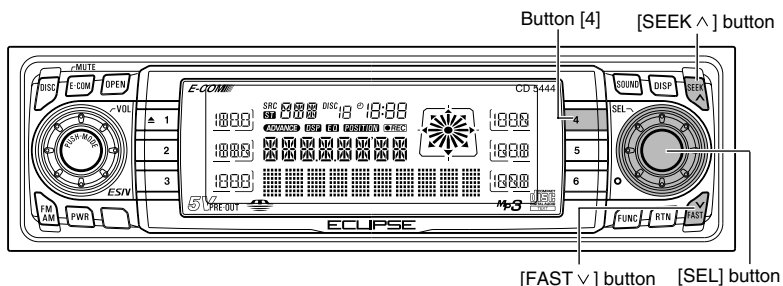

## Advancing to the next track or returning to the beginning of the track being played

- 1 Turn the [SEL] button to the left or right.

Turn to the right: Advances to the next track.

Turn to the left: Returns to the beginning of the track being played. (Repeat turning for previous tracks.)

## Fast Forward/Rewind

Fast forward or rewind the song currently being played.

- 1 Press and hold the [SEEK ^] or [FAST v] button.

[SEEK ^] button: Fast forward.

[FAST v] button: Rewind.

## Playing the beginning of tracks (SCAN)

- 1 Press button [4].

Pressing the button causes the player to move up to the next track and play it for 10 seconds, then move up to the next track and play it for 10 seconds, and so on until the button is pressed again.



- To continue playing a desired track, press the button again to stop scanning.
- After the entire disc is scanned once, ordinary playback starts from the point where scanning started.

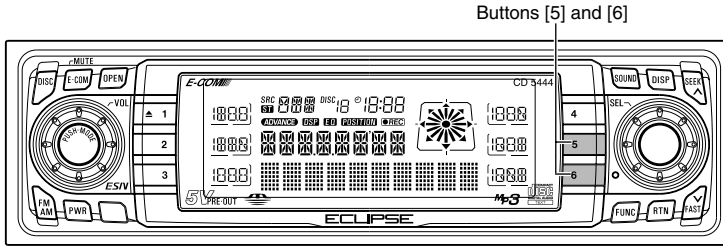

## Repeating the same track (REPEAT)

- 1 Press button [5] to repeat the track being played.

To cancel, press button [5] again.

## Playing tracks in random order (RANDOM)

- 1 Press button [6] to play the tracks in random order.

To cancel, press button [6] again.



- During random playback, press button [5] to repeat the track being played. To cancel repeat play (go back to random play), press button [5] again.

During playback of a particular track: The track being played is played repeatedly.

While searching: The following track is played repeatedly.

- Occasionally the same track happens to be played (selected) two or more times in a row; this is normal operation and is no sign of a problem.
- When any of the functions - "Playing the beginning of tracks," "Repeating the same track" and "Playing tracks in random order" - is selected, a message such as [SCAN], [RPT] or [RAND] appears on the display to verify the current function.

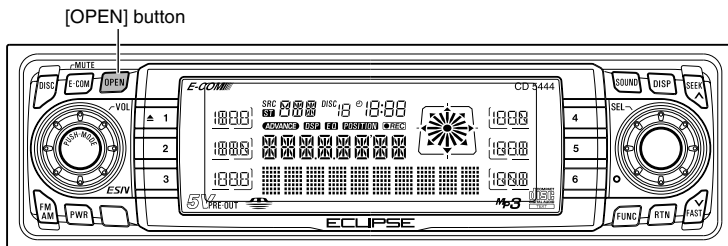

## Ejecting the Memory Stick

- 1 Press the [OPEN] button.

The front panel opens.

- 2 Eject the Memory Stick.

Lightly press the Memory Stick one time.



Memory Stick will not eject by itself. Lightly press the Memory Stick to eject.



- Do not drive with the front panel open. The panel may cause unexpected personal injury during a panic stop, or the like.
- Do not attempt to close the front panel by hand. Doing so may damage the panel.
- Do not eject the Memory Stick while the Memory Stick access indicator illuminated.

- 3 Press the [OPEN] button.

The front panel closes.

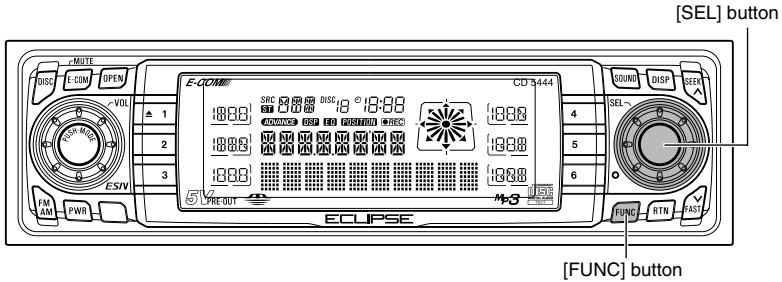

## Recording on Memory Stick

Using ATRAC3 audio compression technology, this deck compresses the music data played on the built-in CD player and records the data on the MG Memory Stick. Only recording from music CDs is possible. If the recorded CD data has no interval, track may not be split properly. As this deck supports SCMS (Serial Copy Management System), MG Memory Stick recording from media (such as CD-R and CD-RW) digitally recorded from music CDs is not possible. Recording data of copy-proof music CDs is not possible either.



- Unrecorded contents, deleted music and vocal data caused by problems, malfunctions and defects of this deck will not be warranted.
- Use of your recordings other than for the personal entertainment is strictly prohibited by the copyright law without permission from the copyright holder.
- Unreproducible recordings should be test recorded first in order to ensure all music and vocal data are recorded properly.
- Do not turn ON/OFF the this deck or ignition switch while recording. The recording will be interrupted and data may be damaged.

**1** Insert the MG Memory Stick to be recording the track and music CD.

**2** Press the [FUNC] button for more than one second.

A music CD playback and recording starts. Press the [FUNC] button for more than one second to stop the recording.



- A track is not recorded if recording is stopped in the middle of the track.
- In case 1 TRACK was selected at the "Selecting tracks to be recorded" on next page step, select tracks using the [SEL] button and start recording.
- A MG Memory Stick formatted by another this deck may not be able to record data.

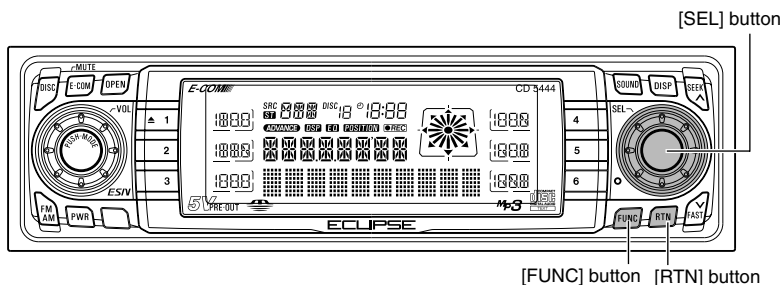

## Selecting tracks to be recorded

The track to be recorded can be selected.

- 1 Press the [FUNC] button for less than one second.

The function mode is activated.

- 2 Turn the [SEL] button to select MS.

- 3 Press the [SEL] button.

The Memory Stick setting mode is activated.

- 4 Turn the [SEL] button to select REC MODE.

- 5 Press the [SEL] button.

The REC mode selection mode is activated.

- 6 Turn the [SEL] button to select ALL or 1 TRACK.

The selection item is highlighted.

ALL: Records all tracks in the disc.

1 TRACK: Records only the selected track.

- 7 Press the [RTN] button.

At this time, other adjustments can also be made in Memory Stick setting mode.

- 8 Press the [RTN] button.

At this time, other adjustments can also be made in function mode.

- 9 Press the [FUNC] or [RTN] button to exit function mode.

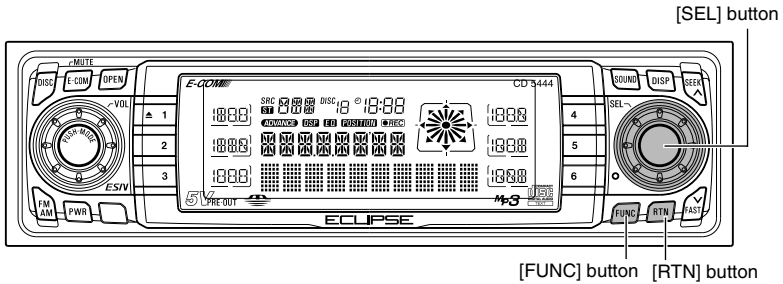

## Setting sound quality

The recording sound quality (the recording bit rate) can be set. The recording bit rate may be selected from 66k, 105k and 132k. Sound quality and data size increases as the bit rate increases.

- 1 Press the [FUNC] button for less than one second.

The function mode is activated.

- 2 Turn the [SEL] button to select MS.

- 3 Press the [SEL] button.

The Memory Stick setting mode is activated.

- 4 Turn the [SEL] button to select REC QUALITY.

- 5 Press the [SEL] button.

The REC quality selection mode is activated.

- 6 Turn the [SEL] button to select 66kbps, 105kbps or 132kbps.

- 7 Press the [RTN] button.

At this time, other adjustments can also be made in Memory Stick setting mode.

- 8 Press the [RTN] button.

At this time, other adjustments can also be made in function mode.

- 9 Press the [FUNC] or [RTN] button to exit function mode.

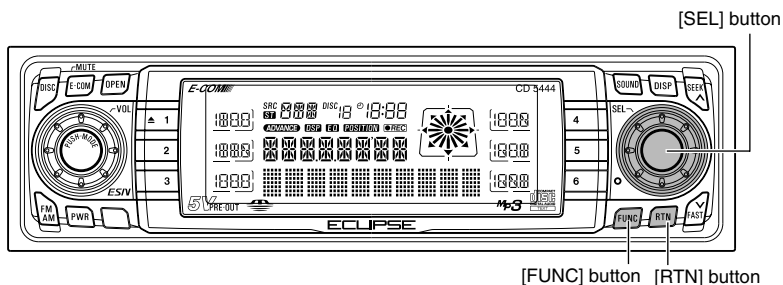

## Deleting recorded file

The recorded files being played can be deleted.

- 1** Press the [FUNC] button for less than one second, when the recording file being played back.

The function mode is activated.

- 2** Turn the [SEL] button to select MS.

- 3** Press the [SEL] button.

The Memory Stick setting mode is activated.

- 4** Turn the [SEL] button to select DELETE.

- 5** Press the [SEL] button.

The file delete mode is activated, then [OK] message will appear.

- 6** Press the [SEL] button for more than two seconds.

The recorded files being played back will be deleted.

- 7** Press the [RTN] button.

At this time, other adjustments can also be made in Memory Stick setting mode.

- 8** Press the [RTN] button.

At this time, other adjustments can also be made in function mode.

- 9** Press the [FUNC] or [RTN] button to exit function mode.



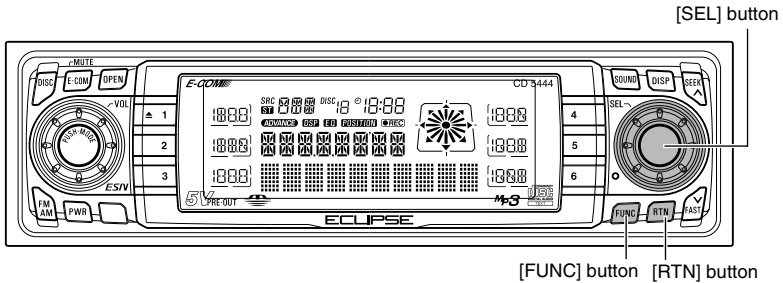

## Formatting MG Memory Stick (quick format)

MG memory stick can be formatted.

- 1** Press the [FUNC] button for less than one second.  
The function mode is activated.
- 2** Turn the [SEL] button to select MS.
- 3** Press the [SEL] button.  
The Memory Stick setting mode is activated.
- 4** Turn the [SEL] button to select FORMAT.
- 5** Press the [SEL] button.  
The format mode is activated, then [OK] message will appear.
- 6** Press the [SEL] button for more than two seconds.  
MG Memory Stick will be formatted.
- 7** Press the [RTN] button.  
At this time, other adjustments can also be made in Memory Stick setting mode.
- 8** Press the [RTN] button.  
At this time, other adjustments can also be made in function mode.
- 9** Press the [FUNC] or [RTN] button to exit function mode.



- Do not turn ON/OFF the power or the ignition switch while formatting.  
The formatting will be interrupted and the data may be damaged.
- When a Memory Stick is formatted, all data on that Memory Stick will be erased. (Included Memory Stick security recorded data and sound quality data)
- New MG Memory Stick may not be used without formatting. In that case, format (quick format) the stick on this deck so music can be recorded (Hi-Fi directory format). The Memory Stick formatted on a deck other than exclusive MG Memory Stick deck may not be usable on this deck.

## How to operate the tuner

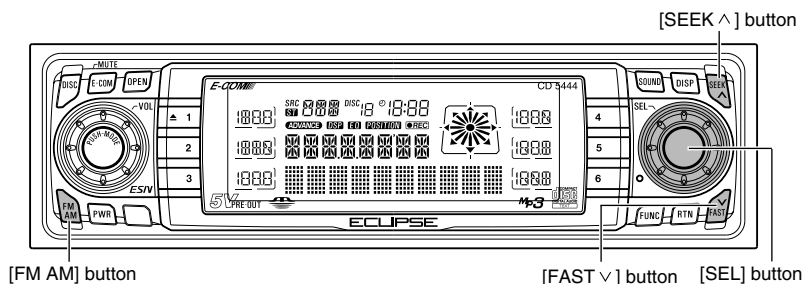

First, press the [FM AM] button to start tuner operation.

There are automatic and manual methods for setting stations in memory. The receiver will accept up to 24 stations in memory: six in AM and 18 in FM (6 each for FM1, FM2 and FM3.) (Initial setting)

## Tuning to a station

- 1 Press the [FM AM] button to switch to the desired FM or AM bands.

Radio bands will switch from FM1 → FM2 → FM3 → AM in order each time the button is pressed.

- 2 Turn the [SEL] button to the left or right to tune to a station.

Turn to the right: Tunes to higher frequencies.

Turn to the left: Tunes to lower frequencies.

- 3 Press the [SEEK ^ / FAST v] button to start the automatic station search.

[SEEK ^] button: Starts searching toward higher frequencies.

[FAST v] button: Starts searching toward lower frequencies.



At times, it may be difficult to maintain optimum reception because the antenna affixed to your vehicle is in motion constantly (relative to the broadcast antenna), encountering continuous variation in the received radio signals' strength. Other factors affecting reception include interference from natural obstacles, sign posts, etc.

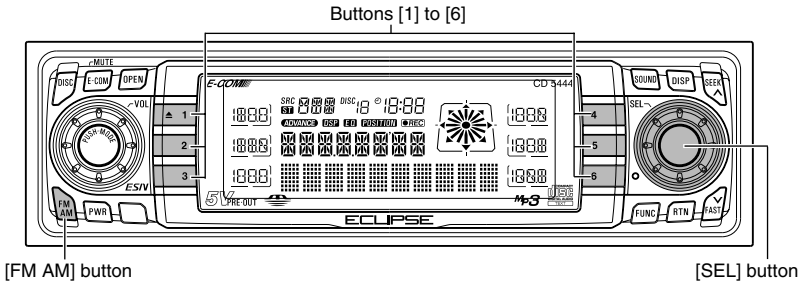

## Entering stations into memory automatically (The automatic preset mode: ASM)

- 1 Press the [FM AM] button to switch to the desired FM or AM bands.

Radio bands will switch from FM1 → FM2 → FM3 → AM in order each time the button is pressed.

- 2 Press the [SEL] button for more than one second until a beep is heard.

The automatic preset mode starts.

The [ASM ON] indicator on the screen flashes, and stations are automatically entered in memory under buttons [1] to [6].

These buttons are called preset buttons.



ATTENTION

- Press any numbered button to select the station whose frequency is indicated right above the button.
- When a new station is set in memory, the station previously set in memory will be deleted.
- If there are fewer than six receivable stations, the stations set in the remaining buttons will be retained.

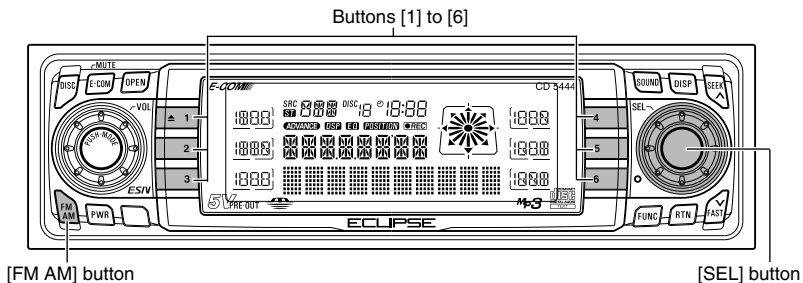

[FM AM] button

[SEL] button

## Manually setting stations into memory

This section covers the setting of stations in memory under the numbered buttons.

- 1** Press the [FM AM] button to switch between FM and AM.
- 2** Turn the [SEL] button to the right or left to tune to the station to be entered in memory.
- 3** Select any button, from [1] to [6], and press it for more than two seconds.

The tuned station is now memorized and set in the button selected. Repeat the procedure to set additional manually tuned stations in memory, in turn, for buttons [1] to [6]. These buttons are called the preset buttons.



Caution

If the vehicle's battery is disconnected (for repairs to the vehicle or for removing the receiver), all stations in memory will be lost. In such a case, set stations in memory again.

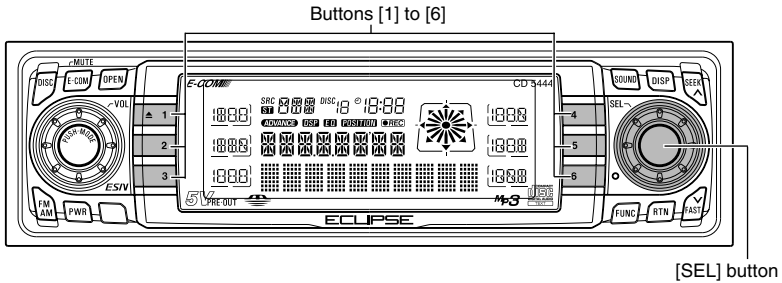

## Preset station scan

This function enables reception of all the stations in the preset buttons for five seconds each.

- 1** Press the [SEL] button for less than one second.

[P SCAN] will appear at the display, and stations stored under preset buttons [1] through [6] will be played for five seconds each.
- 2** To stop the preset scan mode at a desired station, press the [SEL] button again.

The receiver will stay tuned to the desired station.

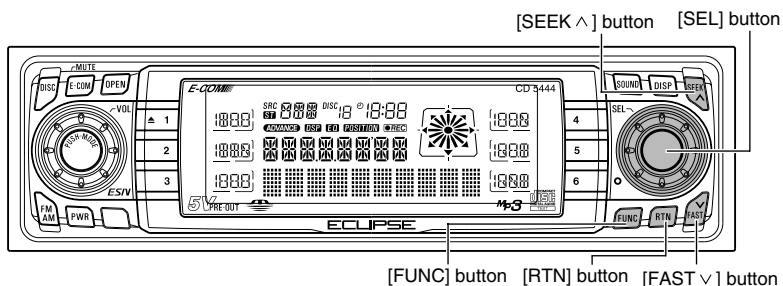

## Setting a station name

Station name settings can be changed.

- 1** Press the [FUNC] button for less than one second while in the tuner mode.
- 2** Turn the [SEL] button to select STATION.
- 3** Press the [SEL] button.  
The station name setting mode is activated.
- 4** Press the [SEEK ^] button to select the character type.  
Pressing the button will switch types from [ABC] (upper-case alphabet characters) to, [123] (numeric characters) and then [!&?] (symbols).
- 5** Press either [SEL] or [FAST v] button to select the position in which to enter the character.

The character will be inserted where the cursor is flashing:

[SEL] button: Moves the cursor to the right.

[FAST v] button: Advances the cursor to the left.

## 6 Turn the [SEL] button to the left or right to select characters.

Turn to the right: Advances the character forward in its type.

Turn to the left: Moves the character backward in its type.

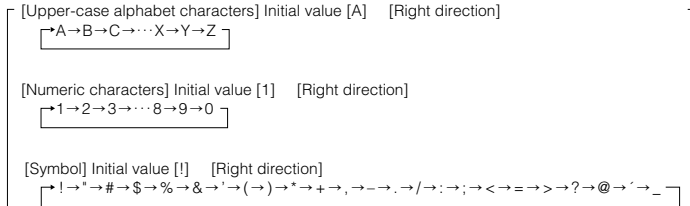

- To change the type of character to be entered, repeat steps 3 and 4.
- A maximum of 10 characters may be entered per station name.
- A maximum of 100 station names may be stored.

## 7 Press the [RTN] button.

At this time, other adjustments can also be made in function mode.

## 8 Press the [FUNC] or [RTN] button to exit function mode.

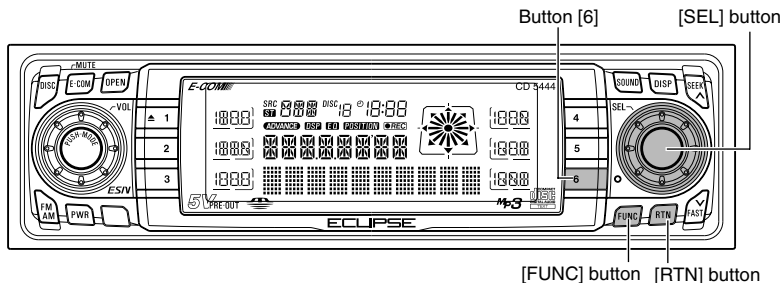

## Deleting a station name

- 1** Press the [FUNC] button for less than one second while in the tuner mode.
- 2** Turn the [SEL] button to select STATION.
- 3** Press the [SEL] button.  
The station name that is displayed at this point will be deleted.
- 4** Hold the [6] button down for more than two seconds.  
The station name has now been deleted.
- 5** Press the [RTN] button.  
At this time, other adjustments can also be made in function mode.
- 6** Press the [FUNC] or [RTN] button to exit function mode.



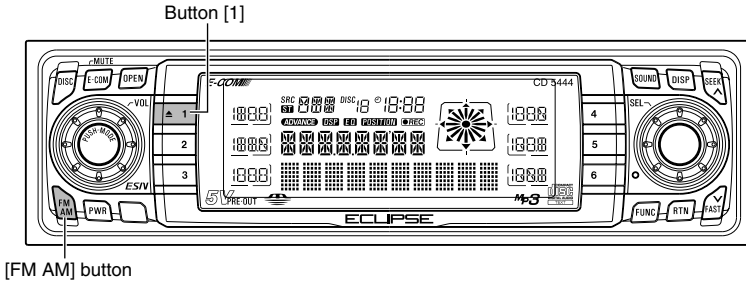

[FM AM] button

## Changing the reception sensitivity for automatic scanning

The deck lets you select the reception sensitivity to be used for automatic scanning of stations. The two sensitivity modes available for this deck are AUTO mode and DX mode.

AUTO Mode	During automatic scanning, the reception sensitivity switches automatically to one of two levels. Initially the reception sensitivity is set to the low level so that only stations with strong signals are received. If no stations could be received, the reception sensitivity is increased so that stations with weaker signals can also be received.
DX Mode	Because the reception sensitivity for automatic scanning is set to the high level from the start, even stations with weaker signals can be received. (Signal crossover may result in some stations being hard to hear.)

- 1** Turn OFF the power.
- 2** Press and hold the [FM AM] button, then button [1], and hold both for more than three seconds.

The mode switches between AUTO mode and DX mode each time the buttons are pressed.

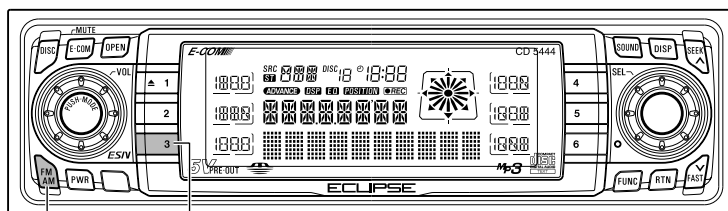

[FM AM] button

Button [3]

## Changing the radio band location

You can switch the location for the radio bands used between the North American region and the Asia/Australia region. The default setting is USA (North America).

- 1** Turn OFF the power.
- 2** Press and hold the [FM AM] button, then button [3], and hold both for more than three seconds.

The radio band switches between USA and OTHERS each time the buttons are pressed.

After changing the location, the power will turn on in FM1 mode. After this, the broadcast stations will be searched for automatically and stored in buttons [1] to [6].

## FM reception characteristics

In general, FM has much better tonal quality than AM. However, FM and FM stereo reception encounter several characteristic problems not encountered with AM. FM is more difficult to receive than AM in a moving vehicle. The following are explanatory notes on what to expect from FM reception and on how to get satisfactory performance.

### FM reception differs from AM

A characteristic of transmitted signals is that lower frequencies travel further. FM frequencies are much higher than AM's (similar to a ray of light): they won't bend but they will reflect. Often, they will be interrupted by tall buildings, mountains, etc., taking direct and indirect paths to your vehicle's antenna. The distance at which FM stations can be received satisfactorily is usually not nearly as far as that which AM stations can be received.

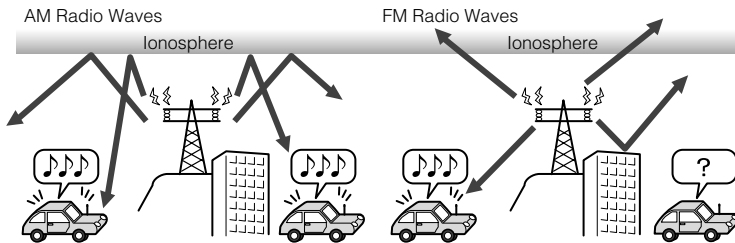

### Fading out

In weak signal or "fringe" reception areas, FM stations may fade out completely, or fade in and out. When driving in weak signal areas, such as near hills, through valleys or tunnels, among tall buildings, etc., you may encounter unusual noise interference. THIS IS NOT A TUNER PROBLEM. In this case, you can only wait until you are in a better reception area, tune to a stronger station, or reduce the treble level.

## Reception area of FM broadcasts

A home receiver can catch weak FM stereo signals through the use of a tall, directional or ultra-sensitive antenna. In a moving vehicle, the area for good reception is limited because of varying conditions encountered while driving, including the types and heights of broadcast antenna structures, signal strength, engine noise, etc. For best reception with manual antenna, extend the antenna mast as far as possible.

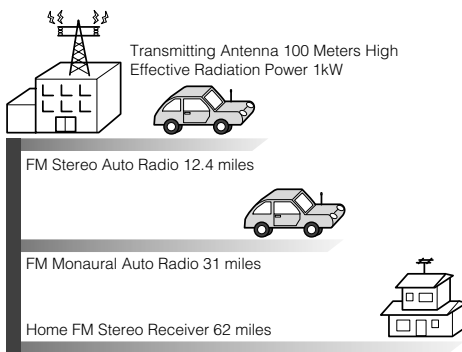

Reception quality varies depending on the power of the FM station, natural and artificial barriers, weather conditions, etc.

## Multipath

The reflection characteristics of FM waves cause another problem called multipath—FM wave signals reflecting off of buildings, mountains, etc. When the antenna receives direct and reflected waves at the same time, distortion of sound in the treble range often occurs, such as static or harsh-sounding voices. THIS IS NOT A TUNER PROBLEM. Only moving to another area with a clearer signal path can remedy the situation.

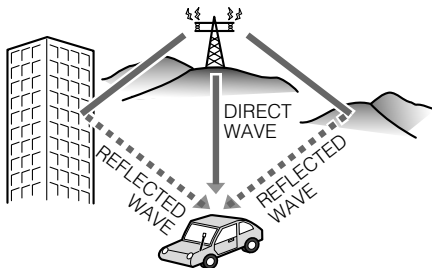

# How to operate the Sound Adjustment Mode

## About Sound Adjustment Mode

This deck is equipped with two different sound adjustment modes: normal mode and advance mode.

Refer to the table below and to the operations for each mode for details of each mode.

The following adjustments can be made in normal mode and advance mode respectively.

	Normal mode	Advance mode
Position selector	<input type="radio"/> (See page 98)	<input type="radio"/>
DSP	<input type="radio"/> (See page 97)	×
Graphic equalizer	×	<input type="radio"/> (See page 101)
Parametric equalizer	×	<input type="radio"/> (See page 104)
Time alignment	×	(Simplified) <input type="radio"/> (See page 106)
Crossover	×	<input type="radio"/> (See page 111)
Multi-harmonizer	×	<input type="radio"/> (See page 112)
Non-fader phase	<input type="radio"/> (See page 99)	<input type="radio"/> (See page 113)
BASS/TREBLE	×	<input type="radio"/>
E-iSERV sound effect customizations	×	<input type="radio"/> (See page 95)

### Position selector

When the position of the listener's seat is selected, the time taken for the sound to travel from the speakers to the listener can then be adjusted in order to obtain a more natural sound orientation. This unit allows up to four different positions to be set.

### DSP

The DSP function reproduces the sensation of various factory set performance environments by adding reverberation to the music being played.

## Graphic equalizer

The graphic equalizer lets you select from six preset equalizer modes in accordance with the genre and instruments of the music being played, and also lets you make fine adjustments within each mode.

## Parametric equalizer

A variety of materials are used inside a vehicle to manufacture the seats and windows, and because these materials absorb and reflect sound in different ways, the parametric equalizer lets you adjust the peaks and dips of the frequency characteristics inside the vehicle to compensate for this.

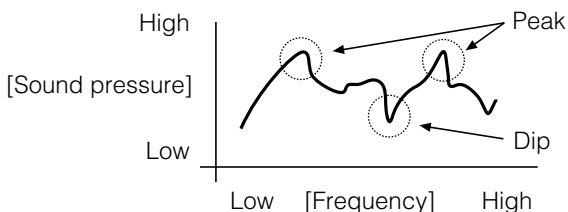

An "equalizer" is a function that corrects these peaks and dips in order to flatten the frequency characteristics. However with a normal graphic equalizer, the median frequency and the Q (sharpness and band width) are fixed, so that when neighboring bands are corrected, there is a limit to the amount by which distortion in the peak and dip characteristics can be corrected.

A "parametric equalizer" lets you adjust the median frequency, Q (sharpness and band width) and gain to variable levels, so that you can make fine adjustments to spot areas of the frequency band.

[Parametric equalizer characteristics]

①. Median frequency can be varied.

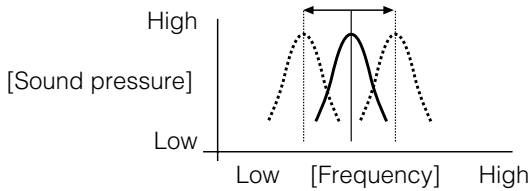

②. Gain can be varied.

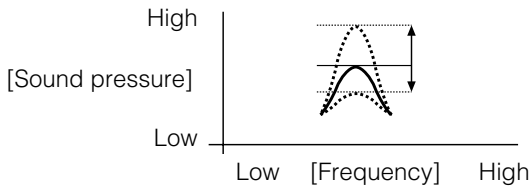

③. Q (sharpness/band width) can be varied.

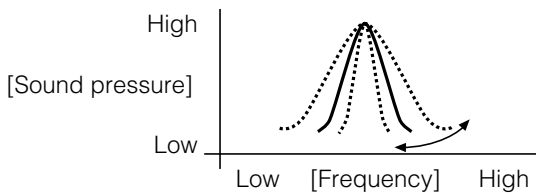

When this deck is in advance mode, a single parametric equalizer function is available in addition to the 13-band graphic equalizer, so that points that cannot be adjusted using the graphic equalizer can be corrected using the single-band parametric equalizer.

## Crossover

The frequency band that is stored by audio media such as CDs is a fairly wide range from 20 Hz to 20 kHz, and it is difficult for a single speaker to be able to play back all frequencies in such a wide range.

Because of this, several speakers can be used, with different frequency bands (such as treble, medium and bass) allotted to each speaker so that wide frequency ranges can be played back.

The "Crossover" function is used to allot the frequency ranges that are to be played back by each speaker in accordance with the installed speaker units and the layout of the speakers, in order to obtain the maximum level of performance from the speakers and to provide the most stable frequency characteristics.

The crossover function includes a high-pass filter (HPF) for playing back treble sounds, and a low-pass filter (LPF) for playing back bass sounds. In addition, the HPF and LPF are used in combination in order to play back sounds in the medium range.

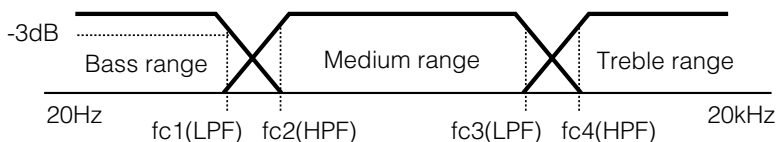

fc\*: Cutoff frequency

For example, when adjusting the HPF, frequencies that are lower than the specified frequency are progressively dampened, rather than simply not being played back at all. The "slope" adjustment function is the function that is used to adjust these dampening characteristics.

The slope characteristics of a filter are such that with larger slope values (for example 12 dB/oct), the slope becomes steeper, and so the amount of sound mixing in with neighboring bands becomes less so that only the target band is played back. However, it also causes the merging of sound between speakers to become poorer and can result in greater distortion.



- The crossover function is a filter that allocates specified frequency bands.
- A high-pass filter (HPF) is a filter that cuts out frequencies that are lower than the specified frequency (bass range) and allows higher frequencies (treble range) to pass through.
- A low-pass filter (LPF) is a filter that cuts out frequencies that are higher than the specified frequency (treble range) and allows lower frequencies (bass range) to pass through.
- The slope is the signal level at which frequencies that are one octave higher or one octave lower are dampened. The larger the slope value, the greater is the slope. In addition, when "PASS" is selected, the slope is eliminated (sound does not pass through the filters), so that the crossover function has no effect.

When this deck is in advance mode, it corresponds to basic speaker systems which comprise front speakers, rear speakers and an added sub-woofer if necessary. In such cases, the crossover can be used to apply the HPF to the front and rear speakers and the LPF to the sub-woofer so that the sound from all speakers merges properly.

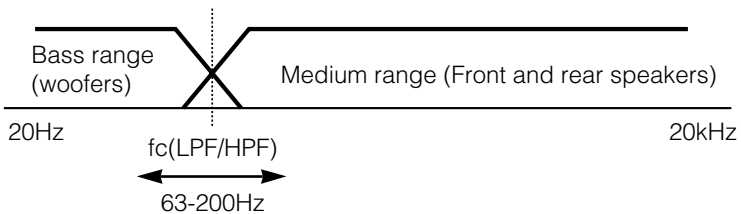

## Time alignment

With vehicle audio systems, the installation position of the speakers and the position of the listener mean that the distances from the listener to the left and right speakers are almost always different. These differences in the distance from the listener to each speaker in turn means that the time taken for the sound to reach the listener is different for each speaker. The result of this is that the phases of each speaker (biases) become mismatched and the sound becomes unnatural, as though the sound stage is not wide enough.

The "time alignment" function corrects the time taken for the sound waves to reach the listener in order to set the optimum phase for the listening position so that the sound becomes more expansive as though it is being listened to on a sound stage.

The basic adjustment method involves measuring the actual distances to each speaker and calculating the differences in distance relative to the most distant speaker in order to derive the delay time for the sound from each speaker.

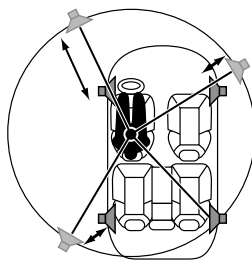

When this deck is in advance mode, a simplified time alignment function is available. You can use this function to adjust only four parameters (position selector, vehicle type, tweeter settings and rear speaker position settings), and so you can make basic time alignment settings without measuring the actual distances to each speaker.

### **Multi-harmonizer**

When original sounds are converted to MP3, ATRAC3 format, frequency ranges that are not normally audible to the human ear are compressed. The multi-harmonizer can be used to play back these compressed sounds at as close to their original form as possible so that clear and powerful sound can be enjoyed.

### **Non-fader phase**

The sounds that are output from woofers include sounds that are in the same frequency ranges that are output from the front and rear speakers, and under the various conditions that can occur inside vehicle compartments, some of these sounds may cancel each other out. This phenomenon can be eliminated by changing the phase of the woofer.

The phase of the woofer can be set to normal timing (in which the output timing between the front and rear speakers and the woofer is the same) or reverse timing (in which the output timing between the front and rear speakers and the woofer is different), depending on the vehicle compartment conditions.

### **E-iSERV sound effect customizations**

The time alignment and crossover functions that are included with this deck can also be adjusted in the same way by means of the ECLIPSE web site (ADVANCE mode only). The procedure for doing this is displayed on the screen, and adjustment is comparatively easy using this method. Access the ECLIPSE web site and follow the instructions that appear on the screen. After doing this, download the adjusted data for the Memory Stick and write it into this deck. (Refer to "Reading sound quality data" on page 114 for details on reading the adjustment data.)

URL: <http://www.eclipse-web.com/>

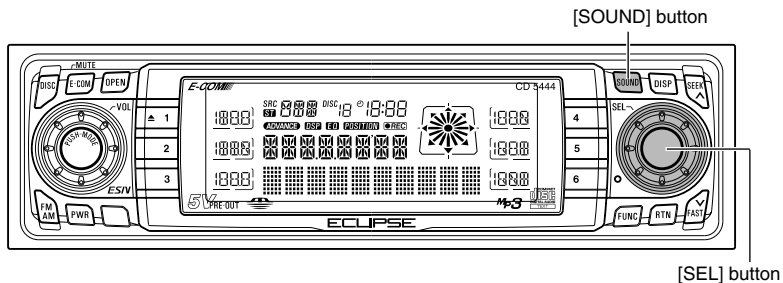

## Operations during Normal Mode

- 1 Press the [SOUND] button for less than one second.

The mode will change to sound adjustment mode.

- 2 Press the [SOUND] button for more than two seconds.

The mode switches between normal mode and advance mode each time the button is pressed. During normal mode, "ADVANCE OFF" and the scroll display appear in the display.



- The default setting is normal mode.
- If you press the [SOUND] button during sound adjustment mode, the adjustment mode is canceled and the mode returns to normal music mode.

- 3 Turn the [SEL] button to select a setting item.

When the button is turned, the setting item changes in the following order.



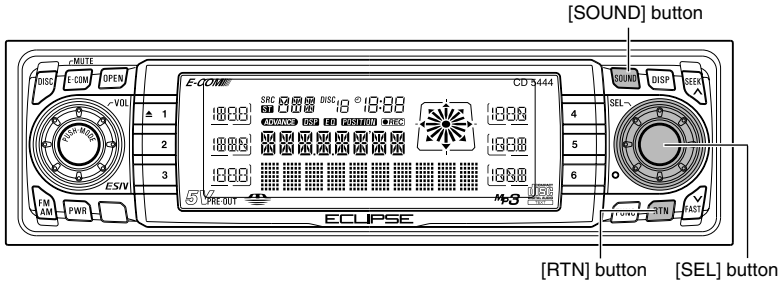

## DSP Setting

The DSP feature adds reverberations to simulate ambience in different types of surroundings (room size).

**1 Turn the [SEL] button to select DSP.**

**2 Press the [SEL] button.**

The DSP mode is activated.

**3 Turn the [SEL] button to select the room size.**

When the button is turned, the setting item changes in the following order.

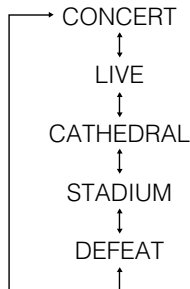

**4 Press the [RTN] button.**

At this time, other adjustments can also be made in normal mode.

**5 Press the [SOUND] or [RTN] button to exit sound adjustment mode.**

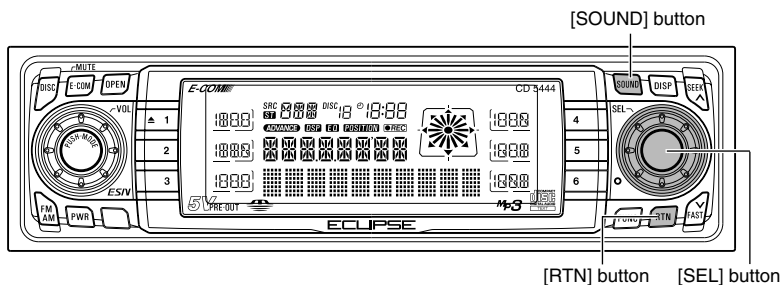

### Position selector setting (POSITION)

When the position of the listener's seat is selected, the time taken for the sound to travel from the speakers to the listener can then be adjusted in order to obtain a more natural sound orientation. This deck allows up to four different positions to be set.

**1 Turn the [SEL] button to select POSITION.**

**2 Press the [SEL] button.**

The mode will change to position selector setting mode.

**3 Turn the [SEL] button to select the setting item.**

When the button is turned, the setting item changes in the following order.



**4 Press the [RTN] button.**

At this time, other adjustments can also be made in normal mode.

**5 Press the [SOUND] or [RTN] button to exit sound adjustment mode.**



If the position selector has been set (to a setting other than OFF), the BAL (balance) and FAD (fader) settings will be canceled.

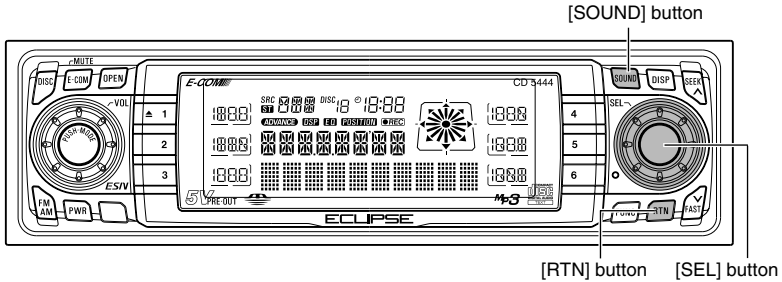

### Non-fader phase selection (NON-FADER)

The merging of sound between the front and rear speakers and the woofer can be improved by selecting the phase. Switch the phase to a phase which lets the speakers combine without any disharmony.

- 1 Turn the [SEL] button to select NON-FADER.**
- 2 Press the [SEL] button.**  
The mode will change to phase selection mode.
- 3 Turn the [SEL] button to select NORMAL or REVERSE.**  
NORMAL: Normal phase  
REVERSE: Reverse phase
- 4 Press the [RTN] button.**  
At this time, other adjustments can also be made in normal mode.
- 5 Press the [SOUND] or [RTN] button to exit sound adjustment mode.**

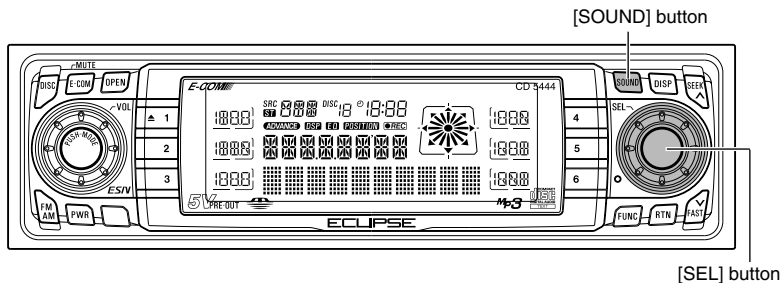

## Operations during Advance Mode

- 1 Press the [SOUND] button for less than one second.

The mode will change to sound adjustment mode.

- 2 Press the [SOUND] button for more than two seconds.

The mode switches between normal mode and advance mode each time the button is pressed. During advance mode, "ADVANCE ON" and the scroll display appear in the display.



If you press the [SOUND] button during sound adjustment mode, the adjustment mode is canceled and the mode returns to normal music mode.

- 3 Turn the [SEL] button to select a setting item.

When the button is turned, the setting item changes in the following order.

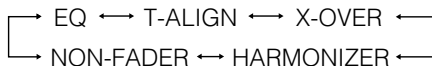



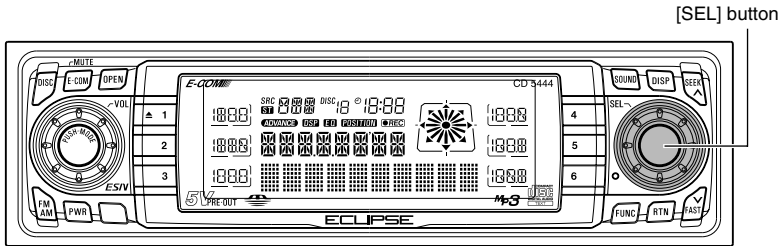

## Equalizer adjustment (EQ)

EQ (equalizer) mode can be used to adjust the frequency of the audio channels being played back in accordance with the genre and instruments of the music being played. In addition, correction of the frequency characteristics inside the vehicle is also possible using the 13-band graphic equalizer and the single-band parametric equalizer.

### Switching equalizer modes

The equalizer mode can be selected as follows.

**1 Turn the [SEL] button to select EQ.**

**2 Press the [SEL] button.**

The mode will change to equalizer adjustment mode.

**3 Press the [SEL] button for less than one second.**

Each time the button is pressed, the setting item changes in the following order.

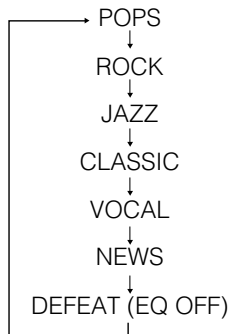

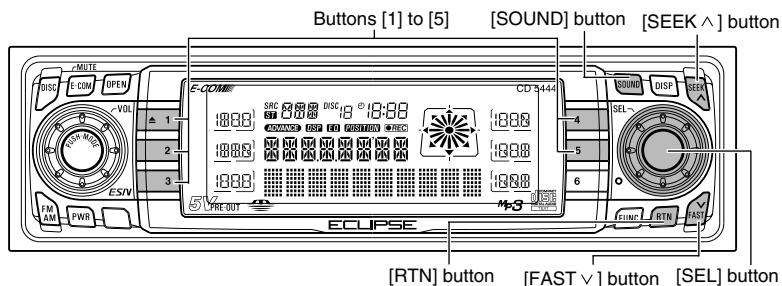

**4 Press the [RTN] button.**

At this time, other adjustments can also be made in advance mode.

**5 Press the [SOUND] or [RTN] button to exit sound adjustment mode.**



The initial EQ settings are factory preset.

**Fine-tuning EQ functions**

Fine adjustments can be made in each equalizer mode.

**1 Select the equalizer mode.**

Refer to the section "Switching equalizer modes" on page 101.

**2 Turn the [SEL] button to select the frequency to be adjusted.**

When the button is turned, the frequency changes in the following order.

63Hz ↔ 100Hz ↔ 160Hz ↔ 250Hz ↔ 400Hz ↔ 630Hz ↔ 1kHz ↔ 1.6kHz ↔ 2.5kHz ↔ 4kHz ↔ 6.3kHz ↔ 10kHz ↔ 16kHz

**3 Press the [SEEK ^ /FAST v] button.**

This adjusts the frequency level.

[SEEK ^] button: Increases level.

[FAST v] button: Decreases level.

**4 Hold down a button, [1] to [5], for more than two seconds to preset a value.**

The preset value is overwritten by the value set using the above steps.

**5 Press the [RTN] button.**

At this time, other adjustments can also be made in advance mode.

**6 Press the [SOUND] or [RTN] button to exit sound adjustment mode.**

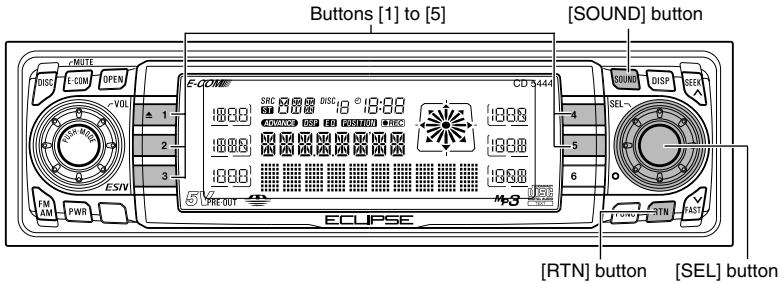

### Selecting an equalizer mode from memory

Press a preset button to select the equalizer mode set in memory for the button. The buttons that set equalizer modes in memory are called preset buttons.

- 1 Turn the [SEL] button to select EQ.**
- 2 Press the [SEL] button.**
- 3 Select any button, from [1] to [5], and press it for less than two seconds.**  
The preset pattern stored in memory will be retrieved.
- 4 Press the [RTN] button.**  
At this time, other adjustments can also be made in advance mode.
- 5 Press the [SOUND] or [RTN] button to exit sound adjustment mode.**



- When the preset value is changed, the display shows as follows:

USER ○  
└─ 1~5 (Preset ch No.)

- Preset button [6] is used to call up the settings downloaded from the E-iSERV (web site) and stored on the Memory Stick.

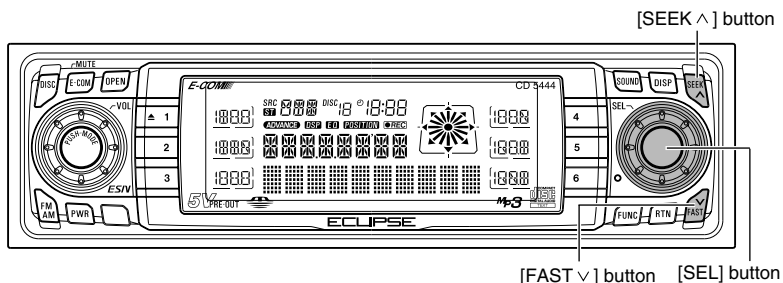

### Making fine adjustments to the parametric equalizer

You can select and adjust frequencies using the parametric equalizer (single-band).



When the following operations are carried out, the parametric equalizer settings that have been made previously will be changed.

- 1 Turn the [SEL] button to select EQ and press the [SEL] button.**
- 2 Press the [SEL] button for more than one second.**  
The mode will change to parametric equalizer adjustment mode.
- 3 Turn the [SEL] button to select the frequency for changing the parametric equalizer settings.**  
When the button is turned, the frequency changes in the following order.  
80Hz ↔ 125Hz ↔ 200Hz ↔ 315Hz ↔ 500Hz ↔ 800Hz ↔ 1.25kHz ↔ 2kHz ↔ 3.15kHz ↔ 5kHz ↔ 8kHz ↔ 12.5kHz
- 4 Press the [SEEK ^ / FAST v] button.**  
This adjusts the frequency level.  
[SEEK ^] button: Increases level.  
[FAST v] button: Decreases level.



[SEL] button

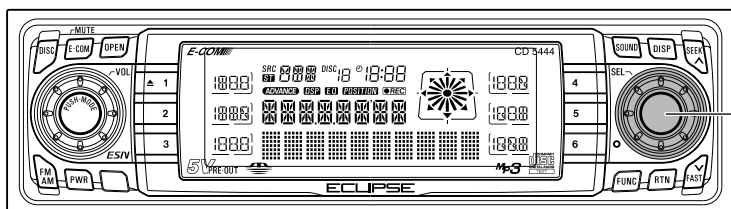

### Simplified time alignment settings (T-ALIGN)

This function corrects the position characteristics and frequency characteristics in order to delay the signals being output from the various speakers so that the signals from each speaker reach the listening position at the same time.

**1 Turn the [SEL] button to select T-ALIGN.**

**2 Press the [SEL] button.**

The mode will change to time alignment setting mode.

**3 Turn the [SEL] button to select a setting item.**

When the button is turned, the setting item changes in the following order.

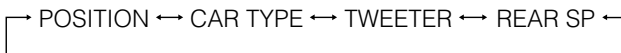

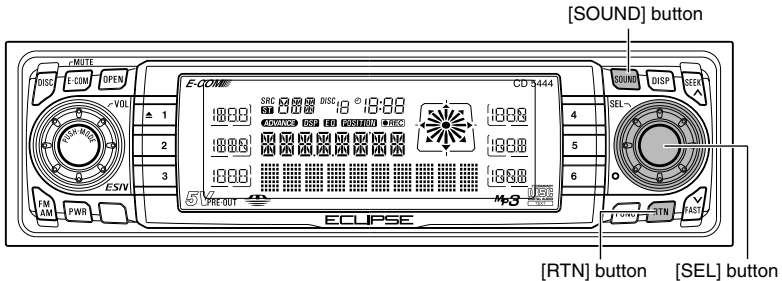

### Position selector setting (POSITION)

When the position of the listener's seat is selected, the time taken for the sound to travel from the speakers to the listener can then be adjusted in order to obtain a more natural sound orientation. This deck allows up to four different positions to be set.

**1 Turn the [SEL] button to select POSITION.**

**2 Press the [SEL] button.**

The mode will change to position selector setting mode.

**3 Turn the [SEL] button to select the setting item.**

When the button is turned, the setting item changes in the following order.



**4 Press the [RTN] button.**

Other time alignment items can be set at this time.

**5 Press the [RTN] button.**

At this time, other adjustments can also be made in advance mode.

**6 Press the [SOUND] or [RTN] button to exit sound adjustment mode.**



If the position selector has been set (to a setting other than OFF), the BAL (balance) and FAD (fader) settings will be canceled.

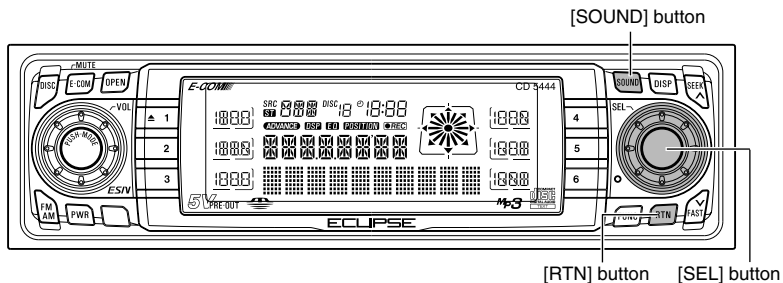

### Selecting the type of vehicle (CAR TYPE)

You can select the time alignment settings to match your vehicle from a range of preset settings for different types of vehicle, allowing you to select the optimum time alignment settings automatically.

**1 Turn the [SEL] button to select CAR TYPE.**

**2 Press the [SEL] button.**

The mode will change to car type selection mode.

**3 Turn the [SEL] button to select the setting item.**

When the button is turned, the setting item changes in the following order and the selected item is highlighted.

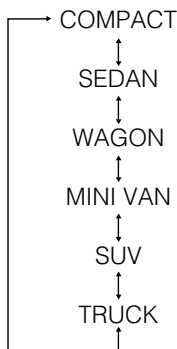

**4 Press the [RTN] button.**

Other time alignment items can be set at this time.

**5 Press the [RTN] button.**

At this time, other adjustments can also be made in advance mode.

**6 Press the [SOUND] or [RTN] button to exit sound adjustment mode.**



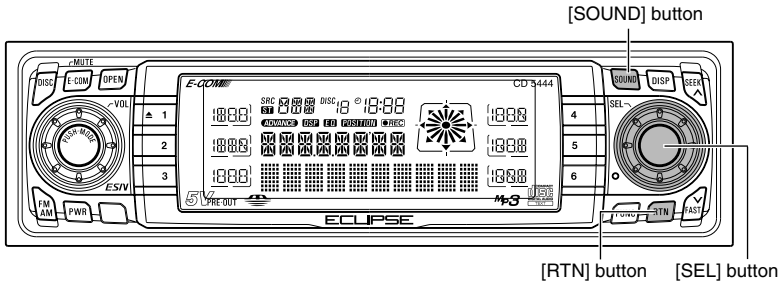

### **Tweeter settings (TWEETER)**

You can select the tweeter installation location and whether or not a tweeter is being used or not, allowing you to select the optimum time alignment settings automatically.

**1 Turn the [SEL] button to select TWEETER.**

**2 Press the [SEL] button.**

The mode will change to tweeter setting mode.

**3 Turn the [SEL] button to select the setting item.**

When the button is turned, the setting item changes in the following order.

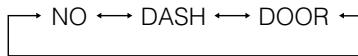

**4 Press the [RTN] button.**

Other time alignment items can be set at this time.

**5 Press the [RTN] button.**

At this time, other adjustments can also be made in advance mode.

**6 Press the [SOUND] or [RTN] button to exit sound adjustment mode.**



If the front speakers have been installed to the dash panel, you can set the tweeter setting to "DASH" even if no tweeter has been installed.

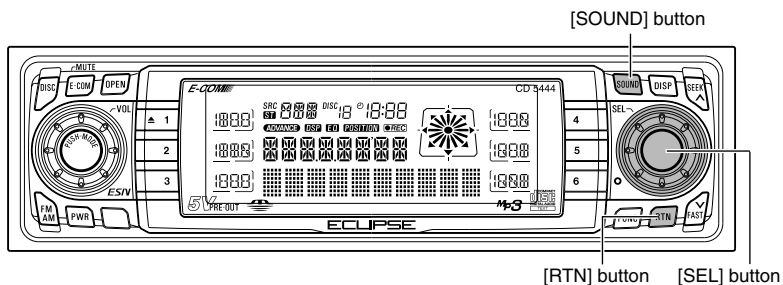

### **Rear speaker position selection (REAR SP)**

You can select the rear speaker installation location, allowing you to select the optimum time alignment settings automatically.

- 1 Turn the [SEL] button to select REAR SP.**
- 2 Press the [SEL] button.**  
The mode will change to rear speaker position setting mode.
- 3 Turn the [SEL] button to select the setting item.**  
When the button is turned, the setting item changes in the following order.  
DOOR → OTHERS
- 4 Press the [RTN] button.**  
Other time alignment items can be set at this time.
- 5 Press the [RTN] button.**  
At this time, other adjustments can also be made in advance mode.
- 6 Press the [SOUND] or [RTN] button to exit sound adjustment mode.**

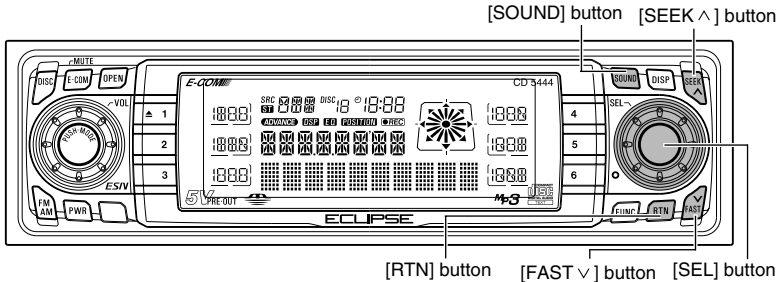

## Crossover adjustment (X-OVER)

The frequencies for the front and rear speaker high-pass filter (HPF) and woofer low-pass filter (LPF) can be set within a range of 63 to 200 Hz. (This is the same as the HPF and LPF cut-off frequencies.)

- 1 Turn the [SEL] button to select X-OVER.**  
The selected item will be highlighted.
- 2 Press the [SEL] button.**  
The mode will change to crossover setting mode.
- 3 Turn the [SEL] button to select the cut-off frequency.**  
When the button is turned, the frequency changes in the following order.  
63Hz ↔ 80Hz ↔ 100Hz ↔ 125Hz ↔ 160Hz ↔ 200Hz ↔
- 4 Press the [SEEK ^ / FAST v] buttons to set the slope.**  
[SEEK ^] button: PASS  
[FAST v] button: 12dB/oct



ATTENTION

If no woofer has been connected, set the slope adjustment to "PASS". (If you set the slope to 12 dB/oct, the bass sound will not be output from the speakers.)

- 5 Press the [RTN] button.**  
At this time, other adjustments can also be made in normal mode.
- 6 Press the [SOUND] or [RTN] button to exit sound adjustment mode.**

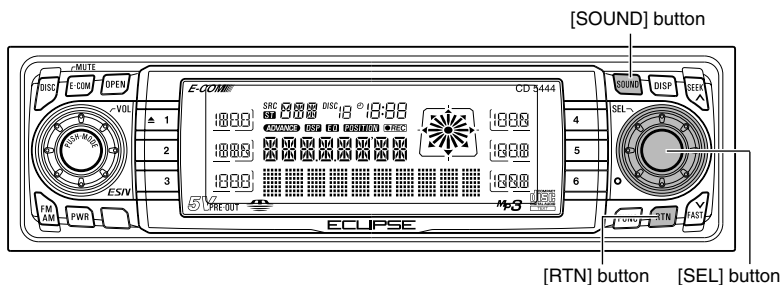

## Multi-harmonizer settings (HARMONIZER)

This function uses harmonic synthesis to restore the high-frequency component that is lost as a result of the compression process so that fresher sound can be obtained during MP3, ATRAC3 playback.

**1 Turn the [SEL] button to select HARMONIZER.**

**2 Press the [SEL] button.**

The mode will change to multi-harmonizer setting mode.

**3 Turn the [SEL] button to select the setting item.**

When the button is turned, the setting item changes in the following order.

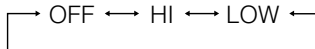

HI: High effectiveness

LOW: Low effectiveness

**4 Press the [RTN] button.**

At this time, other adjustments can also be made in advance mode.

**5 Press the [SOUND] or [RTN] button to exit sound adjustment mode.**

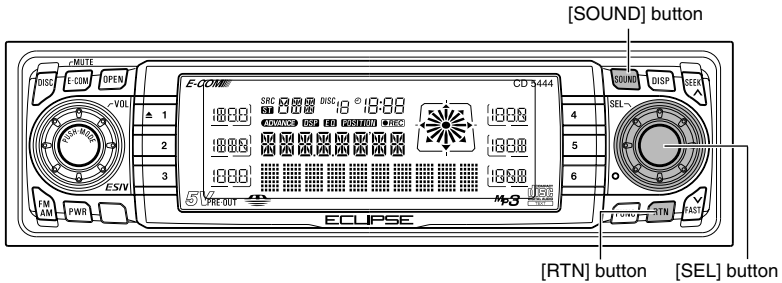

### Non-fader phase selection (NON-FADER)

The merging of sound between the front and rear speakers and the woofer can be improved by selecting the phase. Switch the phase to a phase which lets the speakers combine without any disharmony.

- 1 Turn the [SEL] button to select NON-FADER.**
- 2 Press the [SEL] button.**  
The mode will change to phase selection mode.
- 3 Turn the [SEL] button to select NORMAL or REVERSE.**  
NORMAL: Normal phase  
REVERSE: Reverse phase
- 4 Press the [RTN] button.**  
At this time, other adjustments can also be made in advance mode.
- 5 Press the [SOUND] or [RTN] button to exit sound adjustment mode.**

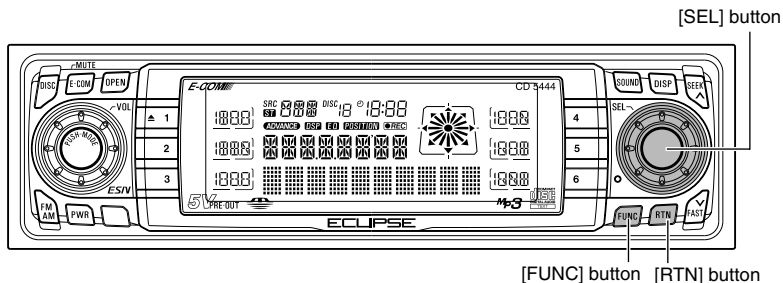

### Reading sound quality data

The sound quality data that has been downloaded from E-ISERV (web site) to a Memory Stick can be loaded into the deck and saved there.

- 1 Insert the memory stick to be used for reading the data.**
- 2 Press the [FUNC] button.**  
The function mode is activated.
- 3 Turn the [SEL] button to select Data Read.**
- 4 Press the [SEL] button.**  
The data reading mode is activated.
- 5 Turn the [SEL] button to select the saving file.**
- 6 Press the [SEL] button.**  
The selected file will be saved.

When reading has finished, [Completed] will appear on the display and then it will return to the display for selecting the function mode.



- Make a folders in the Memory Stick and download the data adjust through E-iSERV (web site) as shown below.

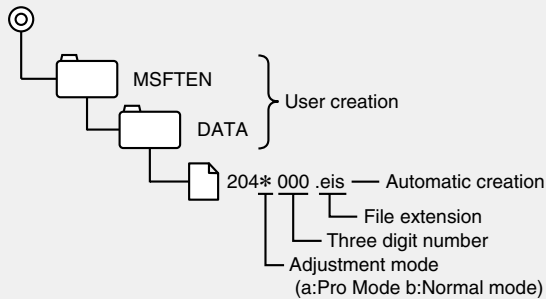

- The files that can be read by this deck are created automatically when you are downloading from the E-iSERV (web site).
- The sound quality data that is read (crossover adjustment values and time alignment adjustment values) are stored automatically in preset button [6]. During equalizer mode (Advance mode), you can retrieve the adjustment values in the saved data by pressing button [6] for two seconds or more.

**7 Press the [FUNC] or [RTN] button to exit function mode.**

## *How to use the Card remote control*

### **Precautions in use of the remote control**

- Be careful when handling the control, especially because it is small and light. Dropping or striking it hard may damage it, wear out the battery or cause a malfunction.
- Keep the remote control free of moisture, dust and water. Do not subject it to shock.
- Do not place the remote control unit where it will get hot, such as on the dashboard or near a heater vent. Allowing the remote control unit to overheat may warp its case or cause other problems.
- Do not operate the remote control unit while driving because doing so could cause an accident.
- When using the remote control, point it directly at the remote control light receptor.
- The light receptor may not operate correctly if it is exposed to bright light such as direct sunlight.
- Be sure to press the [PWR] button on the main unit for more than two seconds to shut it down before leaving the car, or the car battery may be run down. When the main unit is shut down, the remote control will not work.
- Remove the batteries from the remote control unit whenever it is not to be used for a long time.

### **Cleaning the remote control**

- Use a dry cloth to keep the unit clean. If the remote control unit gets extremely dirty, clean it with a cloth moistened in dilute liquid detergent. Do not use alcohol or thinner; these compounds may damage the finish.
- In no event should benzine or thinner be used. These substances will damage the case or finish.





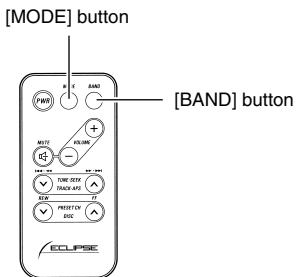

## Switching playback modes

- 1 Press the [MODE] button.

Press the button to switch modes in the following sequence:

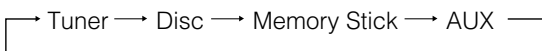

## How to play the tuner

Select the tuner mode first.

### Selecting the FM/AM band

- 1 Press the [BAND] button.

Each press will switch tuner modes from FM1 → FM2 → FM3 → AM.

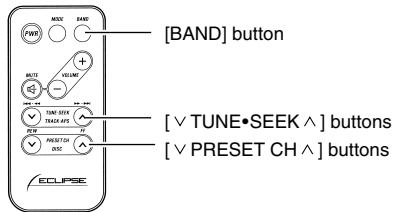

### Selecting a station (manually or automatically)

A short press of the button will allow manual station tuning. Pressing for more than one second will start automatic tuning.

#### 1 Press the [∨ TUNE•SEEK ∧] button.

[∧] button: Tunes to higher frequency stations.

[∨] button: Tunes to lower frequency stations.

### Selecting preset stations

A total of six stations may be selected (preset tuning) out of those already set in memory through the main unit. (Refer to "Manually setting stations into memory," page 80.)

#### 1 Press the [∨ PRESET CH ∧] button.

[∧] button: Select the next higher number preset button.

[∨] button: Select the next lower number preset button.

## How to play CDs

Select the disc mode first.

### Switching disc modes

#### 1 Press the [BAND] button.

When one or two CD changers are connected, press the [BAND] button to change modes from CD player → CD changer 1 → CD changer 2.

The indicator will skip a changer or player that has no discs loaded.

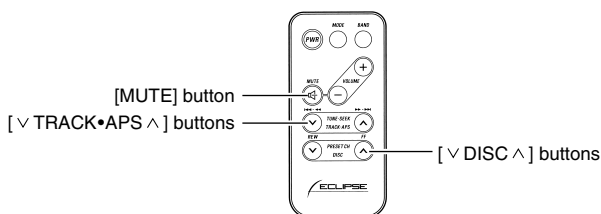

## Advancing to the next track or returning to the beginning of the track being played

### 1 Press the [∨ TRACK•APS ∧] button.

[∧] button: Skips to the next track.

[∨] button: Returns to the beginning of the track being played. (Press repeatedly to move to previous tracks.)



ATTENTION

Hold the [∧] button down to fast forward, or the [∨] button to rewind through the track being played.

## Skipping to the next or previous disc

### 1 Press the [∨ DISC ∧] button.

[∧] button: Selects the next higher number disc.

[∨] button: Selects the next lower number disc.

## Enabling the optional E-COM feature

Pressing the [MUTE] button for one second will switch the E-COM feature on or off.

## Replacing the battery



To prevent accidents, store batteries out of the reach of children. If a child has swallowed one, consult a doctor immediately.

Use one CR2025 battery.

- 1** On the back of the remote control, while pressing the locking knob on the battery slot cover toward your right, pull out the battery carrier with your fingernail.

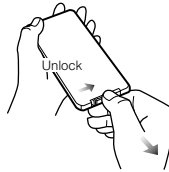

- 2** Remove the old battery, then place the new one in the carrier with the (+) mark facing up.

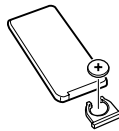

- 3** Push in the carrier until it snaps into place.

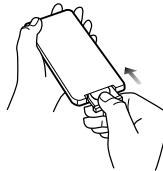

Be extremely careful not to swallow the battery.

## How to use an optional NOB remote control

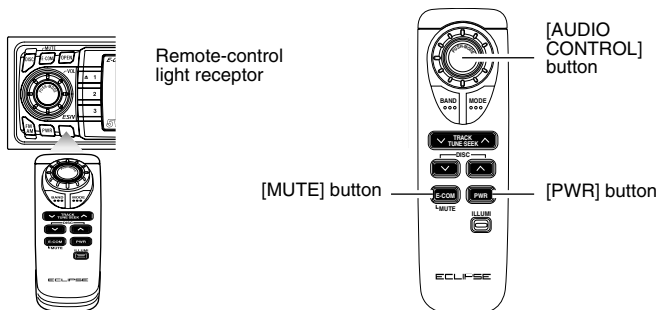

### Turning the power on/off

When the power is turned on, the state used when the power was turned off such as CD and tuner playing is restored.

- 1 Press the [PWR] button.

The power turns on or off each time the button is pressed.



When the main unit is shut down, the remote control will not work.

### Adjusting the audio volume

- 1 Press the [AUDIO CONTROL] button, and turn it to the left or right.

Each press of the button will switch the audio control modes.

Turn to the right: Increases the volume.

Turn to the left: Decreases the volume.

#### Muting the volume

Press the [MUTE] button for more than one second to cut the volume or restore it instantly.



Press the [MUTE] button for more than one second if E-COM is connected and less than one second if E-COM is not connected to cut the volume or restore it instantly.

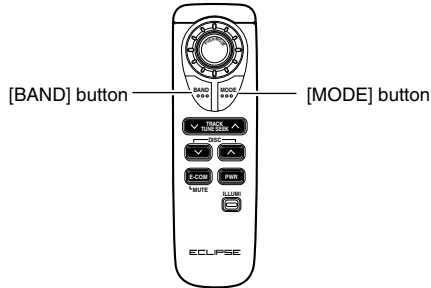

## Switching playback modes

- 1 Press the [MODE] button.

Press the button to switch modes in the following sequence:

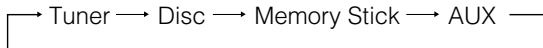

## How to play the tuner

Select the tuner mode first.

### Selecting the FM/AM band

- 1 Press the [BAND] button.

Each press will switch tuner modes from FM1 → FM2 → FM3 → AM.

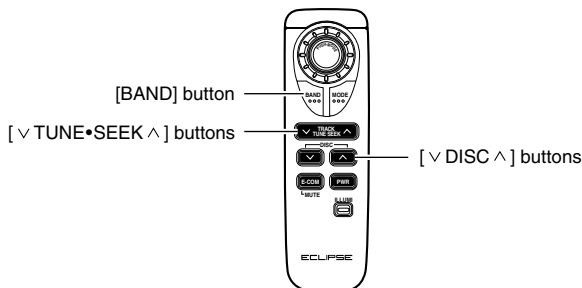

### Selecting a station (manually or automatically)

A short press of the button will allow manual station tuning. Pressing for more than one second will start automatic tuning.

#### 1 Press the [∇ TUNE•SEEK ▲] button.

[▲] button: Tunes to higher frequency stations.

[∇] button: Tunes to lower frequency stations.

### Selecting preset stations

A total of six stations may be selected (preset tuning) out of those already set in memory through the main unit. (Refer to "Manually setting stations into memory," page 80.)

#### 1 Press the [∇ DISC ▲] button.

[▲] button: Selects the next higher number preset button.

[∇] button: Selects the next lower number preset button.

## How to play CDs

Select the disc mode first.

### Switching disc modes

#### 1 Press the [BAND] button.

When one or two CD changers are connected, press the [BAND] button to change modes from CD player → CD changer 1 → CD changer 2.

The indicator will skip a changer or player that has no discs loaded.



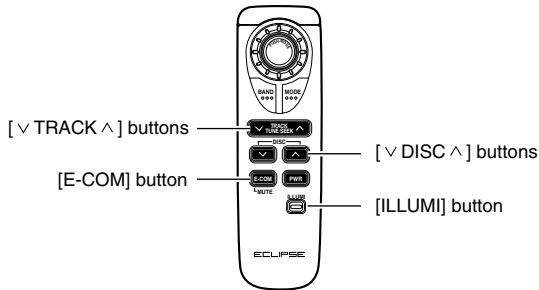

## Advancing to the next track or returning to the beginning of the track being played

### 1 Press the [ √ TRACK ^ ] button.

[ ^ ] button: Skips to the next track.

[ √ ] button: Returns to the beginning of the track being played. (Press repeatedly to move to previous tracks.)



Hold the [ ^ ] button down to fast forward, or the [ √ ] button to rewind through the track being played.

## Skipping to the next or previous disc

### 1 Press the [ √ DISC ^ ] button.

[ ^ ] button: Selects the next higher number disc.

[ √ ] button: Selects the next lower number disc.

## Illuminating the NOB remote control

The buttons of the NOB remote control will be illuminated by pressing the [ILLUMI] button.

## Enabling the optional E-COM feature

Pressing the [E-COM] button for one second will switch the E-COM feature on or off.

## Replacing the battery



To prevent accidents, store batteries out of the reach of children. If a child has swallowed one, consult a doctor immediately.

Use two AA-size batteries.

- 1** Remove the back cover of the remote control unit by gently pressing and sliding it in the direction indicated by the arrow.

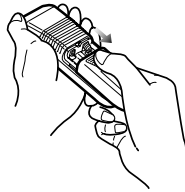

- 2** Install the two batteries provided into the compartment as illustrated inside the compartment.

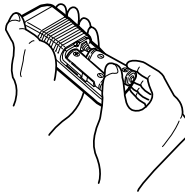

- 3** Return the back cover into place by sliding it in the direction indicated by the arrow.

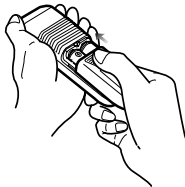



- Be extremely careful not to swallow the battery.
- The battery life is approximately one year. If the remote control unit does not operate correctly or if the button lamp gets dim, replace the batteries.
- Be sure to orient the batteries correctly so that the positive and negative poles match the diagram.
- Do not use one new battery and one old one; use two new batteries.
- Use only two of the same kind of battery.
- If any liquid is seen leaking from the batteries, remove both batteries and dispose of them properly. Thoroughly clean the battery compartment with a dry cloth. Then install new batteries.

## How to operate the receiver with an optional CD changer connected

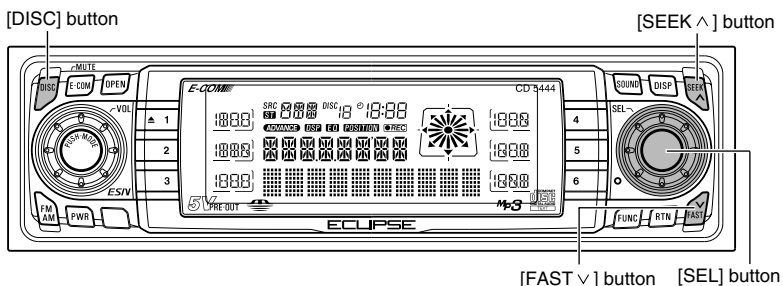

This section covers the operation of an optional CD changer that is connected to the receiver.

To switch from another mode, press the [DISC] button.

### Listening to a CD

- 1 Press the [DISC] button.

Each press of the button switches the mode from CD Player → Memory Stick Player → CD Changer 1 → CD Changer 2.

A changer or player with no discs loaded will be skipped.

### Advancing to the next track or returning to the beginning of the track being played

- 1 Turn the [SEL] button to the left or right.

Turn to the right: Advances to the next track.

Turn to the left: Returns to the beginning of the track being played. (Repeat turning for previous tracks.)

### Fast Forward/Rewind

Fast forward or rewind the song currently being played.

- 1 Press and hold the [SEEK ^] or [FAST v] button.

[SEEK ^] button: Fast forward.

[FAST v] button: Rewind.

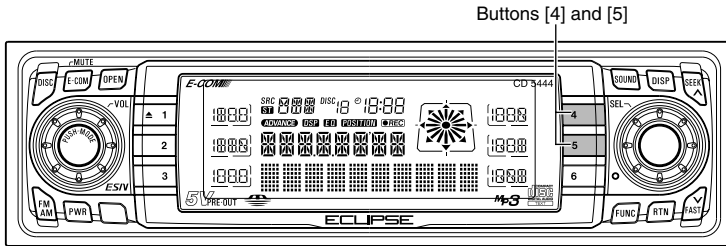

## Playing the beginning of tracks (SCAN)

### 1 Press button [4].

Pressing the button causes the changer to move up to the next track and play it for 10 seconds, then move up to the next track and play it for 10 seconds, and so on, on one CD, until the button is pressed again.

Hold the button until the [ALL SCAN] display appears to play the first 10 seconds of the first track of every CD loaded.



- To continue playing a desired track, press the button again to stop scanning.
- After the entire disc is scanned once, ordinary playback starts from the point where scanning started.

## Repeating the same track (REPEAT)

### 1 Press button [5].

Pressing on the button causes the changer to repeat the track currently being played, until the button is pressed again.

Hold the button until the [ALL RPT] display appears to repeat all tracks on the CD being played.

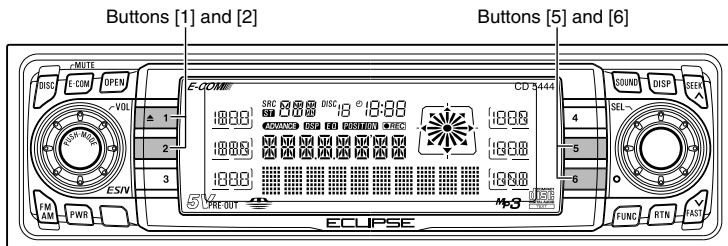

## Playing tracks in random order (RANDOM)

### 1 Press button [6].

Pressing on the button causes the changer to play the tracks on the currently playing CD in random order, until the button is pressed again.

Hold the button until the [ALL RAND] display appears to play tracks from all of CDs loaded in the currently selected changer, in random order.



ATTENTION

- During random playback, press button [5] to repeat the track being played. To cancel repeat play (go back to random play), press button [5] again.

During playback of a particular track: The track being played is played repeatedly.

While searching: The following track is played repeatedly.

- Occasionally the same track happens to be played (selected) two or more times in a row, but it is no sign of a problem.
- When any of the functions - "Playing the beginning of tracks," "Repeating the same track" and "Playing tracks in random order" - is selected, a message such as [SCN], [RPT] or [RND] appears on the display to verify the current function.
- Random play is not canceled even if a magazine is ejected.

## Skipping to the next or previous CD

### 1 Press button [1] or [2].

Button [1]: Selects the next higher number disc.

Button [2]: Selects the next lower number disc.

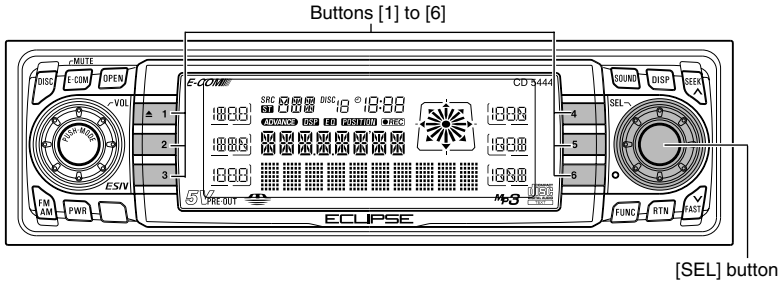

## Specifying a CD to play

A CD of your choice is directly selectable out of the loaded discs.

- 1** Press the [SEL] button for less than one second.
- 2** Press a button from [1] to [6].

Buttons	1	2	3	4	5	6
CD	1	2	3	4	5	6
	7	8	9	10	11	12

To select a CD from nos. 7 to 12, press the desired button considerably longer.

## Others

[DISC] button

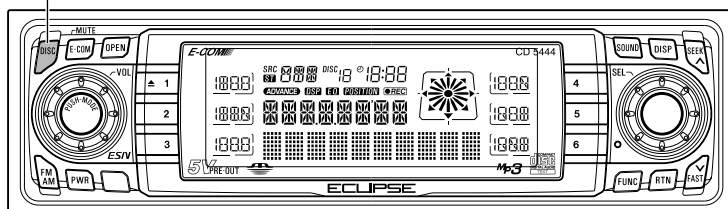

## Connecting Portable Audio Players to the AUX Jack

Use a commonly available accessory cord with stereo mini-plug to connect the audio output jack (LINE) or headphone jack of a portable audio player to the AUX (auxiliary) jack of this system.

- 1** Turn on the portable audio player and start its play function.
- 2** Switch to AUX mode by pressing the [DISC] button for more than one second.

Activation of the AUX mode will light the "AUX" indicator and channel audio player output to the system speakers.



- While the AUX mode is activated, actions such as turning off the audio player or pulling out the connection cord may cause noise spikes that can damage the system speakers. Be sure to avoid this possibility by turning off system power or switching from AUX mode to another mode before shutting off or disconnecting the portable audio player.
- Audio output levels will differ for the various devices that can be connected by this method. Carefully adjust volume until the output level of the connected player is known.
- Before using a portable audio player in a vehicle, read the player's operation manual carefully and confirm problem-free operation in the vehicle before proceeding.



## *If you have a question:*

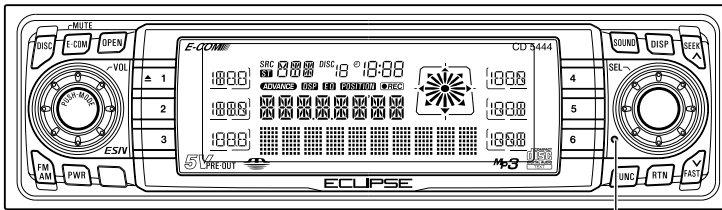

[RESET] button

First check the items mentioned below before attempting to troubleshoot problems.



Caution

If a problem occurs, for instance when the unit does not respond to any button presses, or the display doesn't work correctly, press the [RESET] button using a paper clip or similar item. Pressing the [RESET] button will delete all the entries from memory. The settings will return to those made at the factory prior to shipment.

## Displayed information (for troubleshooting)

The information listed in the chart below is displayed to show the status of the CD, Memory Stick player and CD changer. Refer to the chart for the appropriate action.

Information Contents	Explanation and remedial action to take
INFO 2 NO DISC LOADED IN THE MAGAZINE	There is no disc in the magazine or player. Load a disc in the magazine. (Load a music disc.)
INFO 3 DISCS ARE DIRTY OR DAMAGED	The loaded disc is dirty or upside down. Check it for proper orientation and verify it is clean.
INFO 5 CD PLAYER AND CD CHANGER FAILS MECHANICALLY	<ul style="list-style-type: none"> <li>•The CD player and CD changer is inoperative for some reason. Go through the magazine removal procedure.</li> <li>•If a magazine fails to eject, have your dealer fix problem.</li> </ul>
INFO 6 WHEN THE CD CHANGER INTERNAL TEMPERATURE IS HIGH (TO PROTECT PICKUP UNIT)	<ul style="list-style-type: none"> <li>•The temperature in the CD changer is too high for operation. Wait till it cools down.</li> <li>•Resume playing after the "High temperature sensed and CD stopped" display disappears. If the CD still cannot play, have your dealer repair it.</li> </ul>
INFO 7 AN INTERNAL POWER SUPPLY FAILURE IS OCCURRING WITH THE AUTO CHANGER	<ul style="list-style-type: none"> <li>•Turn the ACC off once before turning it on once again to resume the operation.</li> <li>•If the function still cannot be restricted, contact your dealer.</li> </ul>
LOAD	CD changer is in the process of verifying the presence of CDs after a magazine has been inserted into the CD changer.

Information Contents	Explanation and remedial action to take
MSINFO 1 YOU TRIED TO PLAYBACK AND RECORDING WHEN NO MG MEMORY STICK WAS INSERTED	Insert MG Memory Stick.
MSINFO 2 YOU TRIED TO PLAYBACK AN INCORRECTLY FORMATTED MEMORY STICK	Use the deck to format the Memory Stick.
MSINFO 3 THE WRITE PROTECTION SWITCH IS LOCKED.	Unlock the write protection switch.
MSINFO 4 THE MEMORY STICK FULL	Delete some of the data from the Memory Stick and then start the saving again.
MSINFO 5 YOU TRIED TO RECORD MORE THAN THE MAXIMUM NUMBER OF TRACKS (400) ONTO A MG MEMORY STICK	Delete some of the MG Memory Stick data or use a different MG Memory Stick for recording.
MSINFO 6 AN INCOMPATIBLE MEMORY STICK HAS BEEN INSERTED	Check that the Memory Stick can be used with this deck.
MSINFO 7 MG MEMORY STICK CONTAINING NO MUSIC DATA HAS BEEN INSERTED	Insert a MG Memory Stick containing music data.
MSINFO 8 YOU TRIED TO PLAYBACK DATA THAT INCLUDES A PLAYBACK GUARD	Data that includes a playback guard can not be played back.
MSINFO 9 YOU TRIED TO PLAY BACK AN AUDIO FILE ON AN MG MEMORY STICK WITH PLAYBACK LIMITATIONS.	Data that includes a playback guard can not be played back.
FILE ERR A MG MEMORY STICK CONTAINING INCOMPATIBLE FILES HAS BEEN INSERTED	Insert a MG Memory Stick containing compatible files.
REC ERR YOU TRIED TO RECORD MUSIC FROM AN AUDIO CD SUCH AS A CD-R OR CD-RW TO THE MG MEMORY STICK	This deck is compatible with SCMS/SDMI standards, and so it can not record music from audio CDs such as CD-Rs and CD-RWs.

<b>Mode</b>	<b>Problem</b>	<b>Causes</b>	<b>Remedial action to take</b>	<b>Refer to page</b>
Common to all	Dead or weak sound	Is the volume control up sufficiently?	Turn up the volume control.	42
		Is the muting function in effect (MUTE)?	Cancel the muting (MUTE) function.	42
		Is the fader or balance control set far to one side?	Readjust the fader and balance controls to more normal positions.	43
		Other probable causes include broken audio-signal wiring or a faulty speaker.	Have your dealer check the problem.	—
	Power does not turn on.	Are too many electrical items installed, causing a lack of power?	Have your dealer check the problem.	—
		Other probable causes include a run-down car battery, broken power or interconnection wiring.	Have your dealer check the problem.	—
	Frequencies or titles set in memory are deleted.	Has the car battery been disconnected for repair or checked out?	Reenter them into memory.	79, 80
		Are too many electrical items installed and causing lack of available power?	Have your dealer check the problem.	—
		Other probable causes include run-down car battery, broken power or interconnection wiring.	Have your dealer check the problem.	—
	No guide tone sounds.	Is the guide tone disabled?	Enable the guide tone.	50
	The remote control does not work.	Is the battery low?	Replace battery.	121, 126
		Is the battery installed in reverse polarity?	Reinstall the battery in the correct polarity.	121, 126
		Is direct sunlight hitting the remote control light receptor?	Use the remote control close to the receptor.	—
		Other probable causes include a malfunctioning remote control.	Have your dealer check the problem.	—

Mode	Problem	Causes	Remedial action to take	Refer to page
CD	The disc cannot be inserted. The disc is ejected as soon as it is inserted. Or, the disc cannot be ejected. The disc cannot be changed.	Is an extra label or seal applied to the disc?	Do not apply labels or seals to the disc.	13
		Are there rough edges, deformations or damaged areas on the disc?	Try inserting another disc. Removed any burrs. Do not use a deformed or damaged disc.	14
	Sound skips around. Sound is intermittent. Sound is bad in quality.	Is the disc damaged? (scratched, warped, etc.)	Try another disc. Do not play a damaged disc.	13
		Is the disc clean?	Clean the disc.	15
		Is the player mounted at a proper angle? Is the player mounted loosely?	Have your dealer check it out.	—
		Are you driving over a rough surface?	Avoid playback while driving over rough surfaces.	12
	The disc cannot be ejected.	If unknown	Press the [DISC] button a bit longer and then press the [OPEN] button (forced Eject).	—

Mode	Problem	Causes	Remedial action to take	Refer to page
Tuner	Receives no stations, or receives static noise.	Is the antenna retracted?	Extend the antenna.	—
		Is the tuner correctly tuned to a station?	Tune to a station.	78
		Are you driving outside the service area of your preset stations?	Tune to a local station. (Please note, there may be no local stations servicing the area where you are currently driving.)	78
		Are you operating other equipment with a computer, or a mobile phone, in your vehicle at the same time as your receiver?	Avoid operating such equipment while using the receiver.	—
		Other problems may include a loose or disconnected antenna cable, a bad antenna cable or a bad	Have your authorized Eclipse retailer check the problem.	—

# Specifications

## <GENERAL>

Power Supply	14.4V DC (11-16V)
Current Drain	3A MAX
Dimensions (W x H x D)	
In-Dash Unit	7" x 2" x 6-1/8" (178 x 50 x 155mm)
Mass (weight)	Approx. 1.4kg
Usage temperature range	-20°C to +65°C (-4°F to +149°F )
Storage temperature range	-40°C to +85°C (-40°F to +185°F )

## <FM TUNER>

Frequency Range	
USA:	87.75~107.9MHz (0.2MHz step)
Asia/Australia:	87.5~108MHz (0.05MHz step)
Usable Sensitivity	13dBf
Frequency Response	30~15,000Hz, $\pm 3$ dB
Stereo Separation	38dB

## <AM TUNER>

Frequency Range	
USA:	530~1,710kHz (10kHz step)
Asia/Australia:	522~1,629kHz (9kHz step)
Usable Sensitivity	20 $\mu$ V

## <CD SECTION>

Frequency Response	20~20,000Hz, $\pm 3$ dB
Wow & Flutter	Below measurable limits
Stereo Separation	85dB
S/N Ratio (A-weighted)	100dB
Dynamic Range	98dB
Total Harmonic Distortion	0.006%

## <AUDIO AMPLIFIER>

Power Output	13W x 4 (20~20,000Hz, 0.8% THD, 4 $\Omega$ ) Max. 50W x 4
Output Level/Impedance	5V (0dB CD) 55 $\Omega$ line-out impedance
Tone Action	Bass: $\pm 12$ dB at 63/100Hz Treble: $\pm 12$ dB at 8k/10kHz
Loudness	+10dB at 100Hz/+6dB at 10kHz

## Before installation

### ● Note ●

Be sure to disconnect the vehicle battery's negative terminal before installing the receiver.

## Components

No.	Item	Q'ty
1	Main unit	1
2	Mounting sleeve	1
3	Side bracket	2
4	Rear bracket	1
5	Bezel	1
6	Bushing	1
7	Self-tapping screw (6 x 16 mm)	2
8	Stud bolt	1
9	Flat head screw (5 x 8 mm)	4
10	Hex-head bolt (5 x 20 mm)	2
11	Hex nut (5 mm)	2
12	Interconnecting cable	1
13	Remote control	1
14	Memory Stick	1

## Installation angle

In order to maintain proper functioning, install the unit within an angle of 30 degrees from horizontal (standard). If this is not done, sound skipping or ejection of the CD may occur.

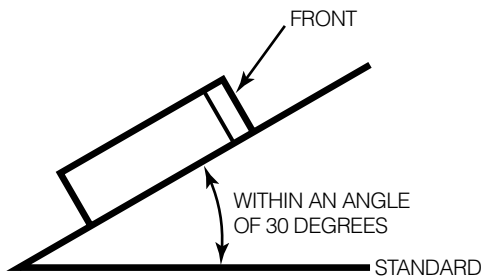

# Mounting instruction

## Mounting the main unit

- 1** Insert the mounting sleeve into the opening in the vehicle dash board or console box.
- 2** Use a screwdriver or the like to bend the tabs in the mounting sleeve to secure the mounting sleeve.

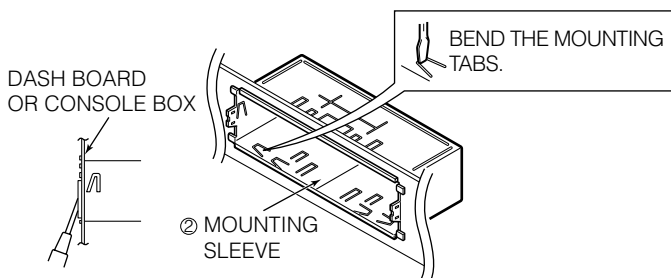

- 3** Attach the side brackets to the main unit using flathead screws.

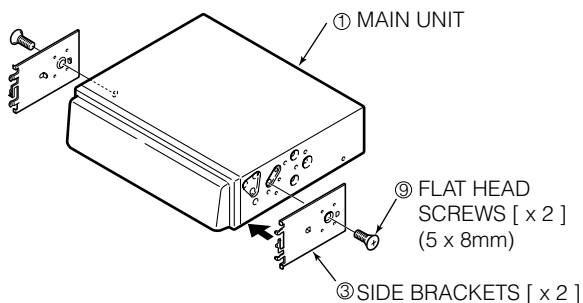



- 4** Mount the stud bolt to the main unit.
- 5** Insert the main unit into the mounting sleeve until it locks in place.
- 6** Fasten the rear of the main unit using either method [A] or [B].

Select method [A] or [B] to suit the interior configuration of the vehicle.

- 7** Install the bezel on the main unit.

Some automobiles may be equipped to secure the back of the main unit using the stud bolt and supplied rubber support.

**[A]**

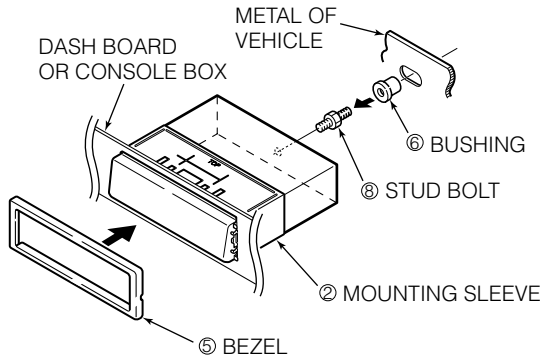

**[B]**

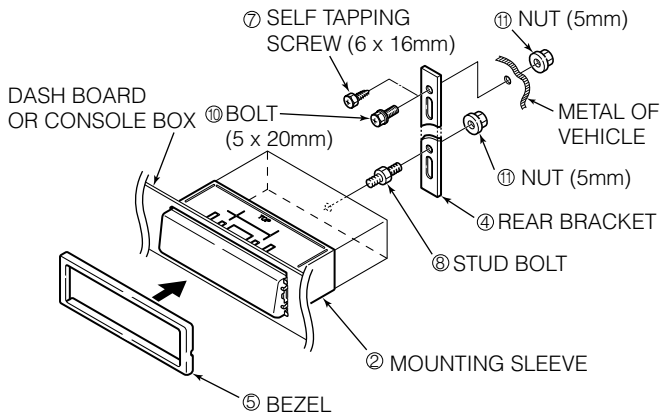

## Names of lead wires and destinations (refer to Page 144)

### ● **Caution** ●

Never connect the power supply to the speaker leads, otherwise it cause damage to the main unit.

### ● **Note** ●

To prevent unconnected leads from shorting out, insulate them by wrapping their tips with electrical tape. Similarly, insulate the ends of connected leads.

If an external amplifier is to be connected to the receiver, be sure to ground its outside housing to the vehicle body (a metal part).

No.	Name	Wire color	Destination
1	ACC	Red	Connect where the power comes on when the ignition is in the ACC position.
2	B+	Yellow	Connect where the power is constantly available, regardless of the ignition switch's position.
3	Ground	Black	Connect where good body grounding is available.
4	Antenna power supply	Blue	Connect to the automatic-antenna control terminal of the vehicle.
5	Lamp power supply	Orange/White	Connect to where power comes on when the headlights are turned on.
6	Control power supply	Blue/White	Connect to the control terminal for the external amplifier, etc.
7	E-LAN terminal		Connect to the E-LAN terminal of the CD changer, DSP, etc.
8 & 9	Line-in/out terminals		Connect to the RCA input connectors of an external amplifier, or to the RCA output connectors of a DSP or EQ.
10	Line-out terminals (Nonfader)		Connect to the RCA input connectors of a DSP or EQ, or the RCA connectors of a woofer amplifier.
11	Speaker leads		Connect them to their respective speaker leads.
12	Cellular phone mute	Pink	Connect to the ground output terminal on a mobile phone.
13	Digital in terminal		Connect to digital output terminal of the CD changer.

# System

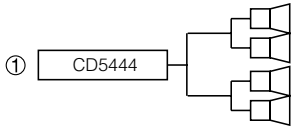

**Note:**  
Adjust the external  
amplifier's input level.

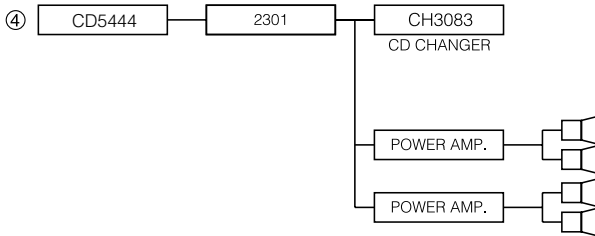
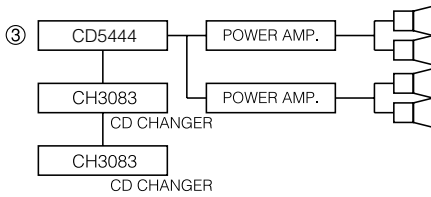
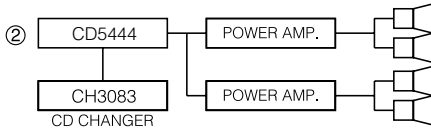

## 1) CD5444 Receiver, used alone

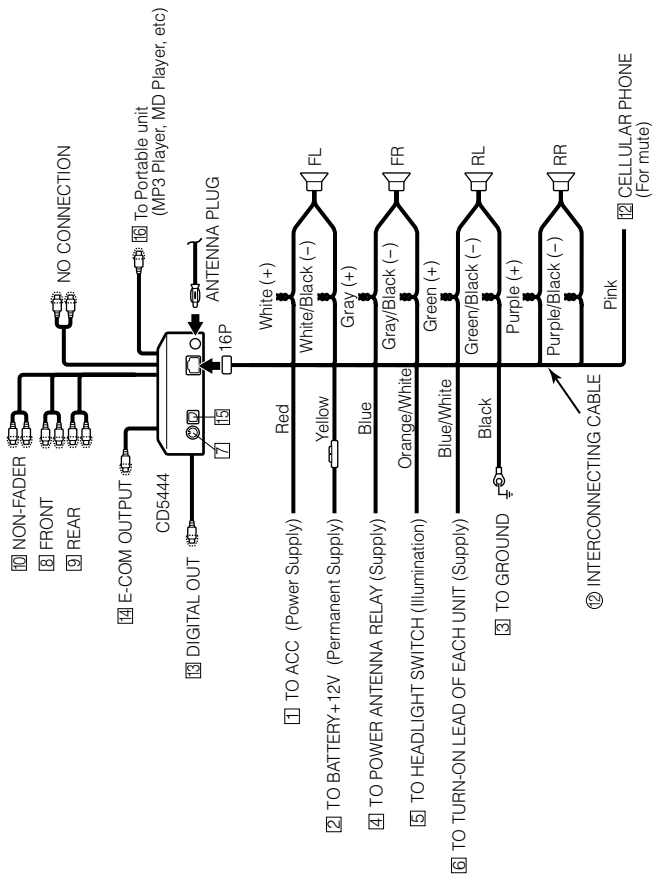

### **Caution**

Never connect the power supply to the speaker leads, otherwise it cause damage to the main unit.

## 2) CD5444 + CH3083 + Power Amplifier

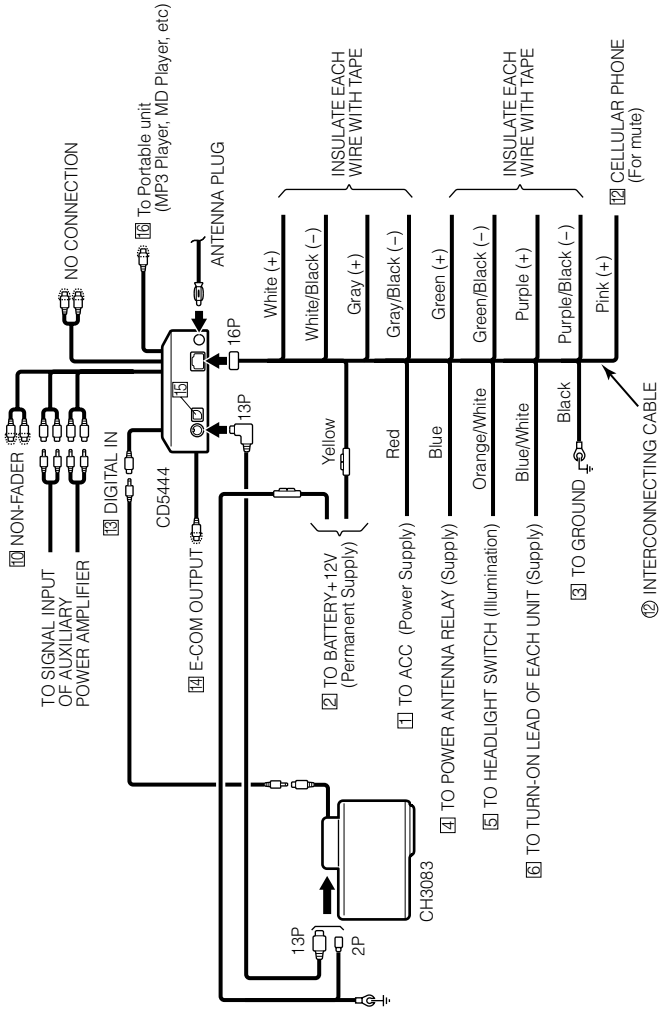

### **Caution**

Never connect the power supply to the speaker leads, otherwise it cause damage to the main unit.

### 3) CD5444 + CH3083 + Power Amplifier

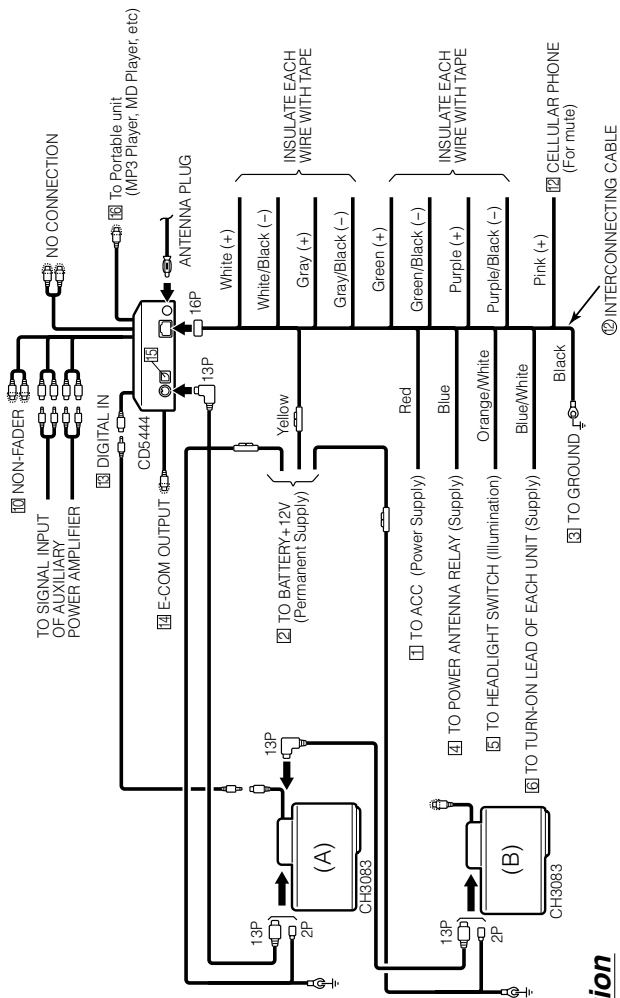

#### **Caution**

Never connect the power supply to the speaker leads, otherwise it cause damage to the main unit.

#### **Note**

1. The switch on the back side of CD changer (A) must be set the "L" position.
2. The switch on the back side of CD changer (B) must be set the "H" position.
3. CD changer (B) does not have digital output.

#### 4) CD5444 + 2301 + CH3083 + Power Amplifier

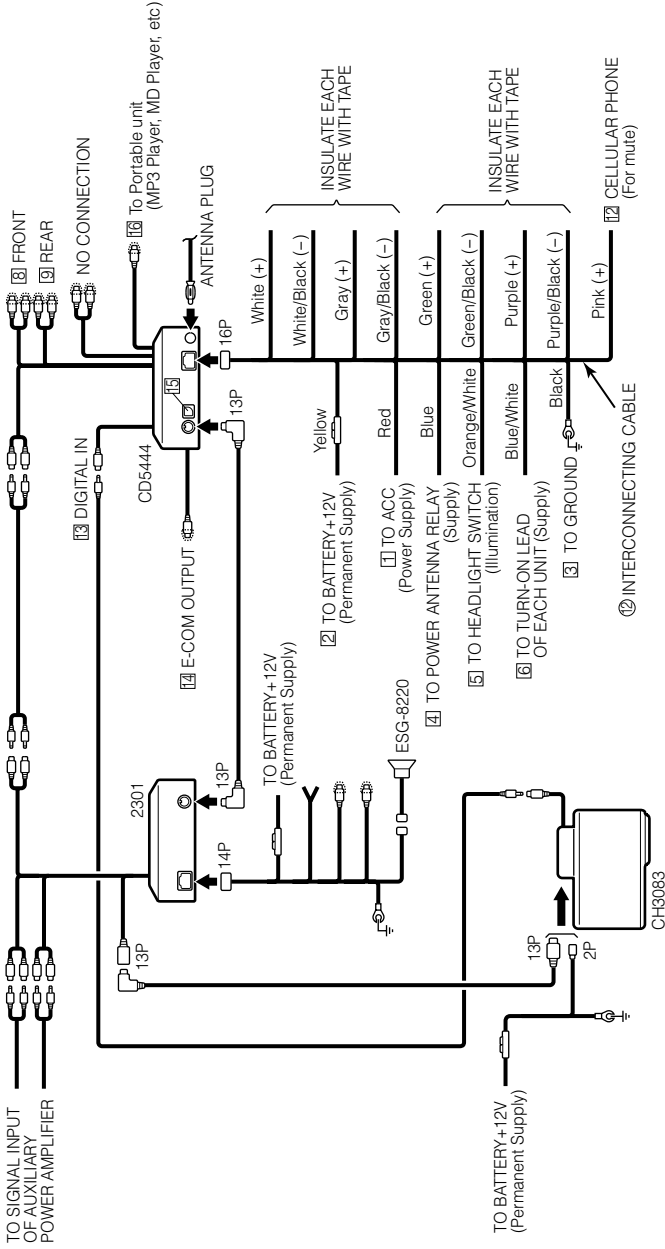

### **Caution**

Never connect the power supply to the speaker leads, otherwise it cause damage to the main unit.

## ***How to contact customer service***

Should the product require service, please contact your nearest following Eclipse dealer.

### **<U.S./CANADA>**

DIVISION OF FUJITSU TEN CORP. OF AMERICA  
19600 SOUTH VERMONT AVENUE, TORRANCE, CA 90502  
Phone: (310) 327-2151

### **<AUSTRALIA>**

FUJITSU TEN (AUSTRALIA) PTY LTD.  
ECLIPSE AUSTRALIA  
Phone: 1800-211-411

### **<MALAYSIA>**

CSE Cobra. Sdn. bhd.  
Level 5, Axis Plaza, Jalan U1/44, Glenmarie, 40150 Shah Alam,  
Selangor D.E., Malaysia.  
Phone: 03-5569-4200  
Fax: 03-5569-4201

### **<SINGAPORE>**

CSE Cobra (S) Pte Ltd  
Trademart  
60, Martin Road, # 05-20, Singapore 239065  
Phone: 6737 2568  
Fax : 6737 9538



## <KOREA>

HYUNDAI AUTONET Co., LTD.

1st FL. Namhyoung Bldg, 746-23 Yeoksam-Dong, Kangnam-Ku,  
Seoul, Korea 135-080

Phone: 02-508-6001

Fax: 02-2-508-6067

Transpectra Co., Ltd.

115-16 nonhyun dong kangnam ku Seoul, Korea.

Phone: 02-540-4595

Fax: 02-2-540-4666

## <TAIWAN>

Sentrek Taiwan, LTD.

1, 9F, Lane 155, Section 3, Peishen RD., Shengkeng, Taipei Hsien,  
222

Taiwan, R.O.C.

Phone: 02-2662-8110

Fax: 02-2662-8117

## <THAILAND>

View Alliance Co., Ltd.

114/9 Soi Suwansawadi, Thungmahamek, Rama 4 Rd., Sathorn,  
Bangkok 10120, Thailand.

Phone: 02-671-9610-12

Fax: 02-671-9614

M e m o .....

# **IMPORTANT**

**RECORD YOUR “KEY CD”  
OR “MEMORY STICK  
(SECURITY CODE)”  
HERE...**

---

---

---

**STORE YOUR “KEY CD”  
OR “MEMORY STICK  
(SECURITY CODE)”  
ALONG WITH YOUR  
OWNER’S MANUAL  
TAKE THIS OUT.**



This device complies with part 15 of the FCC Rules. Operation is subject to the condition that this device does not cause harmful interference.

CUSTOMER NOTICE

Please retain this booklet and write in the serial number of your CD5444 for identification. The serial number is labeled or stamped on the chassis.

Serial No. \_\_\_\_\_



FUJITSU TEN LIMITED